



**PR5030**  
**DLP® Projector**

**USER'S MANUAL**

[www.planar.com](http://www.planar.com)

## **Planar Systems, Inc.**

Corporate Headquarters  
1195 NW Compton Drive  
Beaverton, OR 97006-1992

## **Planar Customer Support**

Telephone:  
US: 1-866-PLANAR1 (866) 752-6271  
Outside US: (503) 748-5799  
E-mail: [PlanarSupport@planar.com](mailto:PlanarSupport@planar.com)  
Online Technical Library: <http://www.planar.com/support>  
24/7 Technical Support

### Copyright

This publication, including all photographs, illustrations and software, is protected under international copyright laws, with all rights reserved. Neither this manual, nor any of the material contained herein, may be reproduced without written consent of the author.

© Copyright February, 2008

### Disclaimer

The information in this document is subject to change without notice. The manufacturer makes no representations or warranties with respect to the contents hereof and specifically disclaims any implied warranties of merchantability or fitness for any particular purpose. The manufacturer reserves the right to revise this publication and to make changes from time to time in the content hereof without obligation of the manufacturer to notify any person of such revision or changes.

### Trademark Recognition

Kensington is a U.S. registered trademark of ACCO Brand Corporation with issued registrations and pending applications in other countries throughout the world.

All other product names used in this manual are the properties of their respective owners and are acknowledged.

## Important Safety Information

Congratulations on purchasing the Planar DLP® projector!

**Important:**

*It is strongly recommended that you read this section carefully before using the projector. These safety and usage instructions will ensure that you enjoy many years of safe use of the projector. Keep this manual for future reference.*

## Symbols Used

Warning symbols are used on the unit and in this manual to alert you of hazardous situations.

The following styles are used in this manual to alert you to important information.

**Note:**

*Provides additional information on the topic at hand.*

**Important:**

*Provides additional information that should not be overlooked.*

**Caution:**

*Alerts you to situations that may damage the unit.*

**Warning:**

*Alerts you to situations that may damage the unit, create a hazardous environment, or cause personal injury.*

Throughout this manual, component parts and items in the OSD menus are denoted in bold font as in this example:

“Push the **Menu** button on the remote control to open the **Main** menu.”

## Remote Control

Some remote controls have a laser for pointing out items on a screen.

**DANGER: Do not point the laser in the eyes. Doing so can damage the eyes permanently.**

## General Safety Information

- Do not open the unit case. Aside from the projection lamp, there are no user-serviceable parts in the unit. For servicing, contact qualified service personnel.
- Follow all warnings and cautions in this manual and on the unit case.
- The projection lamp is extremely bright by design. To avoid damage to eyes, do not look into the lens when the lamp is on.
- Do not place the unit on an unstable surface, cart, or stand.
- Avoid using the system near water, in direct sunlight, or near a heating device.
- Do not place heavy objects such as books or bags on the unit.

### Power Safety

- Only use the supplied power cord.
- Do not place anything on the power cord. Place the power cord where it will not be in the way of foot traffic.
- Remove the batteries from the remote control when storing or not in use for a prolonged period.

### Replacing the Lamp

Replacing the lamp can be hazardous if done incorrectly. Refer to *Replacing the Projection Lamp* on page 35 for clear and safe instructions for this procedure. Before replacing the lamp:

- Unplug the power cord.
- Allow the lamp to cool for about one hour.

### Important Recycle Instructions:



Lamp(s) inside this product contain mercury. This product may contain other electronic waste that can be hazardous if not disposed of properly. Recycle or dispose in accordance with local, state, or federal Laws. For more information, contact the Electronic Industries Alliance at [WWW.EIAE.ORG](http://WWW.EIAE.ORG). For lamp specific disposal information check [WWW.LAMPRECYCLE.ORG](http://WWW.LAMPRECYCLE.ORG).

### Cleaning the Projector

- Unplug the power cord before cleaning. Refer to “Cleaning the Projector” on page 39.
- Allow the lamp to cool for about one hour.

### Regulatory Warnings

Before installing and using the projector, read the regulatory notices in the “Regulatory Compliance” section on page 49.

### Symbol Explanations



DISPOSAL: Do not use household or municipal waste collection services for disposal of electrical and electronic equipment. EU countries require the use of separate recycling collection services.

## Main Features

- Lightweight unit, easy to pack away and transport
- Compatible with all major video standards including NTSC, PAL, and SECAM
- A high brightness rating allows for presentations in daylight or in lit rooms
- Supports resolutions up to WXGA at 16.7 million colors to deliver crisp, clear images
- Flexible setup allows for front, rear & ceiling mounted projections
- Line-of-vision projections remain square, with advanced keystone correction for angled projections
- Input source automatically detected

## Register Your Planar Products Today

Thank you for choosing Planar. To assure you receive all the benefits of your Planar product and services, register your Planar product today. Visit our website to register your product at

[http://www.planar.com/support/product\\_registration.html](http://www.planar.com/support/product_registration.html)

## Cables, Replacement Lamps and Accessories

To find cables, replacement lamps and accessories for your Planar projector, LCD monitor, touchscreen or other Planar products visit our online store at [www.PlanarOnline.com](http://www.PlanarOnline.com) or find other stores who carry Planar products at <http://www.planar.com/howtobuy>

## About this manual

This manual is intended for end users and describes how to install and operate the DLP® projector. Wherever possible, relevant information—such as an illustration and its description—has been kept on one page. This printer-friendly format is both for your convenience and to help save paper, thereby protecting the environment. It is suggested that you only print sections that are relevant to your needs.

Table of Contents

**GETTING STARTED..... 1**

- PACKING CHECKLIST ..... 1
- VIEWS OF PROJECTOR PARTS..... 2
  - Front-right View* ..... 2
  - Top view—On-screen Display (OSD) buttons and LEDs*..... 3
  - Rear view*..... 4
  - Bottom view*..... 6
- REMOTE CONTROL PARTS ..... 7
- REMOTE CONTROL OPERATING RANGE..... 9
- PROJECTOR AND REMOTE CONTROL BUTTONS..... 9

**SETUP AND OPERATION..... 10**

- INSERTING THE REMOTE CONTROL BATTERIES ..... 10
- CONNECTING INPUT DEVICES ..... 11
- STARTING AND SHUTTING DOWN THE PROJECTOR..... 13
- SETTING AN ACCESS PASSWORD (SECURITY LOCK) ..... 15
- ADJUSTING THE PROJECTOR LEVEL ..... 16
- ADJUSTING THE ZOOM, FOCUS AND KEYSTONE ..... 17
- ADJUSTING THE VOLUME ..... 17

**ON-SCREEN DISPLAY (OSD) MENU SETTINGS ..... 18**

- OSD MENU CONTROLS ..... 18
  - Navigating the OSD*..... 18
- SETTING THE OSD LANGUAGE..... 19
- OSD MENU OVERVIEW ..... 20
- OSD SUB-MENU OVERVIEW ..... 21
- IMAGE MENU..... 22
  - Image Menu Functions Available for Connected Source*..... 23
  - Advanced Feature*..... 24
- COMPUTER MENU..... 26
  - Computer Menu Functions Available for Connected Source*..... 26
- VIDEO/AUDIO MENU ..... 27
  - Video/Audio Menu Functions Available for Connected Sources*..... 28
  - Audio*..... 28
- INSTALLATION I MENU..... 29
  - Installation I Menu Functions Available for Connected Sources*..... 30
- INSTALLATION II MENU ..... 31
  - Advanced Feature*..... 32
  - Status*..... 34

**MAINTENANCE AND SECURITY ..... 35**

- REPLACING THE PROJECTION LAMP..... 35
  - Resetting the Lamp*..... 38
- CLEANING THE PROJECTOR..... 39
  - Cleaning the Lens* ..... 39
  - Cleaning the Case*..... 39
- USING THE KENSINGTON® LOCK ..... 40

**TROUBLESHOOTING ..... 41**

- COMMON PROBLEMS AND SOLUTIONS ..... 41
- TIPS FOR TROUBLESHOOTING ..... 41
- LED ERROR MESSAGES ..... 42
- IMAGE PROBLEMS..... 42
- LAMP PROBLEMS ..... 43
- REMOTE CONTROL PROBLEMS ..... 43
- AUDIO PROBLEMS ..... 43

**SPECIFICATIONS ..... 44**

---

INPUT/OUTPUT CONNECTORS .....	44
PROJECTION DISTANCE VS. PROJECTION SIZE .....	45
<i>Projection distance and size table</i> .....	45
TIMING MODE TABLE .....	46
PROJECTOR DIMENSIONS .....	48
<b>REGULATORY COMPLIANCE.....</b>	<b>49</b>
FCC WARNING.....	49
CANADA .....	49
SAFETY CERTIFICATIONS.....	49
EN 55022 WARNING .....	49



# Getting Started

## Packing Checklist

Carefully unpack the projector and check that the following items are included:

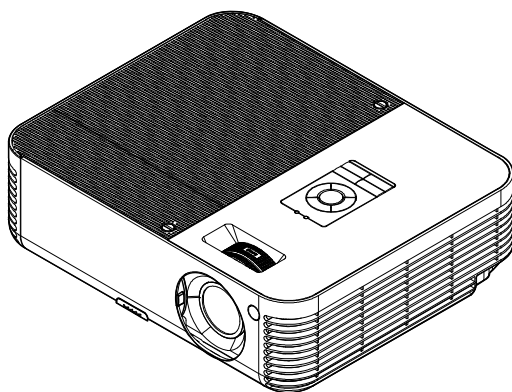

DLP® projector

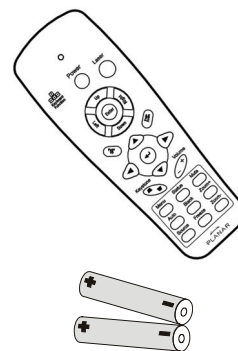

Remote control  
(with two AAA batteries)

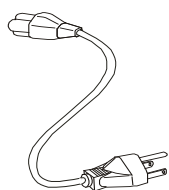

Power cord

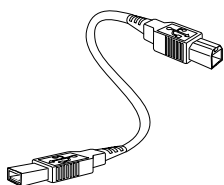

USB cable  
(USB type A-to-B USB)

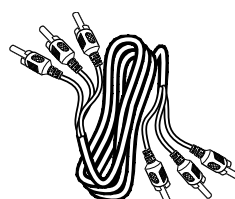

Composite video cable  
(RCA 3-to-RCA 3)

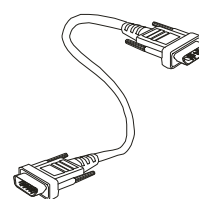

Computer cable  
(VGA-VGA)

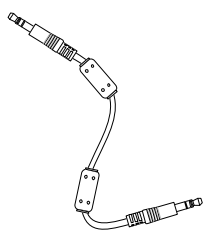

Audio cable  
(mini jack-to-mini jack)



CD-ROM (This User's  
manual)



Users Guide

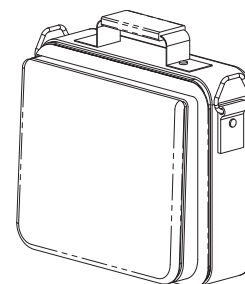

Carrying case

Contact your dealer immediately if any items are missing, appear damaged, or if the unit does not work.

**Caution:**

*Avoid using the projector in dusty environments.*

Views of Projector Parts

Front-right View

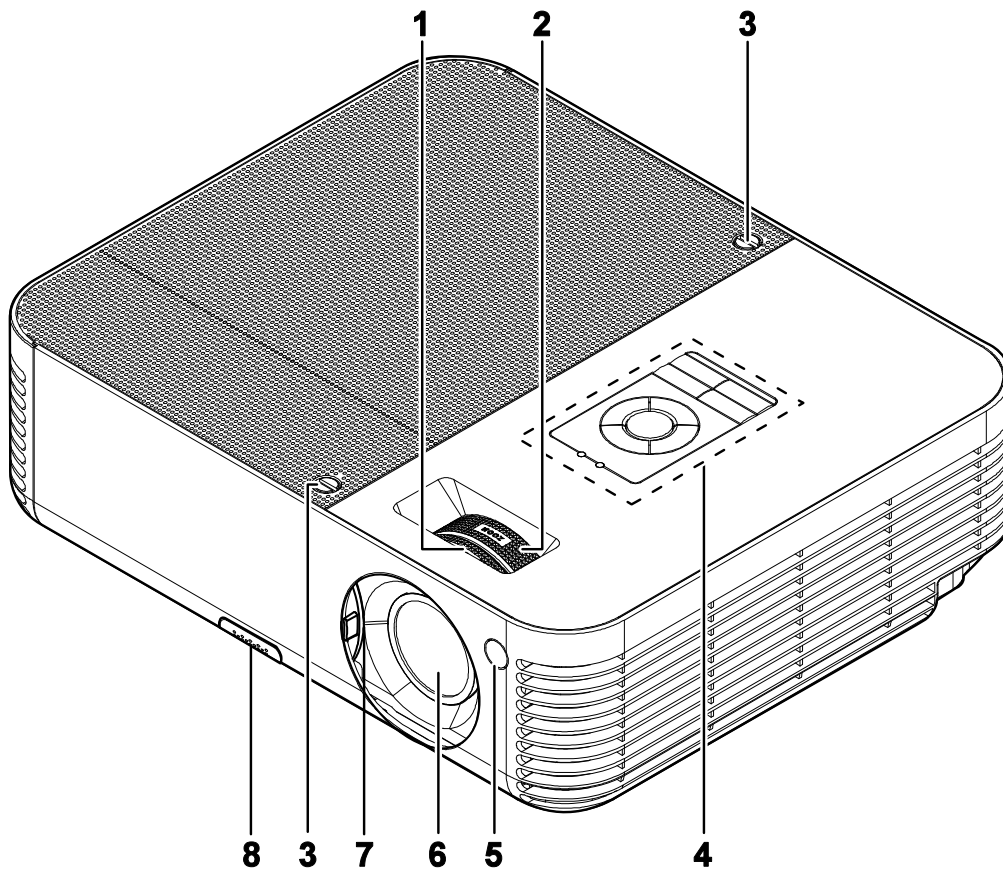

Item	Label	Description	See page:
1.	Focus	Focuses the projected image	17
2.	Lens zoom	Enlarges the projected image	17
3.	Screws	Holds lamp to projector	35
4.	See “Top view—OSD buttons and LEDs”		3
5.	Front IR receiver	Receiver for IR signal from remote control	7
6.	Lens	Slide lens cap before use.	
7.	Lens cover	Slide across to protect lens when not in use	
8.	Height-adjuster button	Push to release height adjuster	16

**Important:**

*Ventilation openings on the projector allow for good air circulation, which keeps the projector lamp cool. Do not obstruct any of the ventilation openings.*

Top view—On-screen Display (OSD) buttons and LEDs

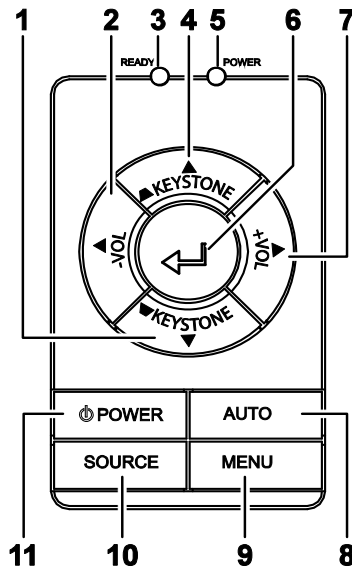

Item	Label	Description	See page:
1.	Keystone/ Down cursor	Corrects image-trapezoid (wider top) effect Navigates and changes settings in the OSD	17, 18
2.	VOL-/ Left cursor	Decreases volume Navigates and changes settings in the OSD	17, 18
3.	Ready LED	Orange	Lamp ready—you can safely turn on or off the projector
		Flashing	Lamp not ready—do not press the power button
4.	Keystone/ UP cursor	Corrects image-trapezoid (wider bottom) effect Navigates and changes settings in the OSD	17, 18
5.	Power LED	Green	Unit is powered on and working correctly
		Off	Unit is powered off
		Flashing	Operational error code (refer to “LED Error Messages” on page 42)
6.	Enter	Changes settings in the OSD	18
7.	VOL+/ Right cursor	Increases volume Navigates and changes settings in the OSD	17, 18
8.	Auto	Optimizes image size, position, and resolution Navigates and changes settings in the OSD	13
9.	Menu	Opens and exits the OSD	
10.	Source	Detects the input device	
11.	Power	Turns the projector on or off	

Rear view

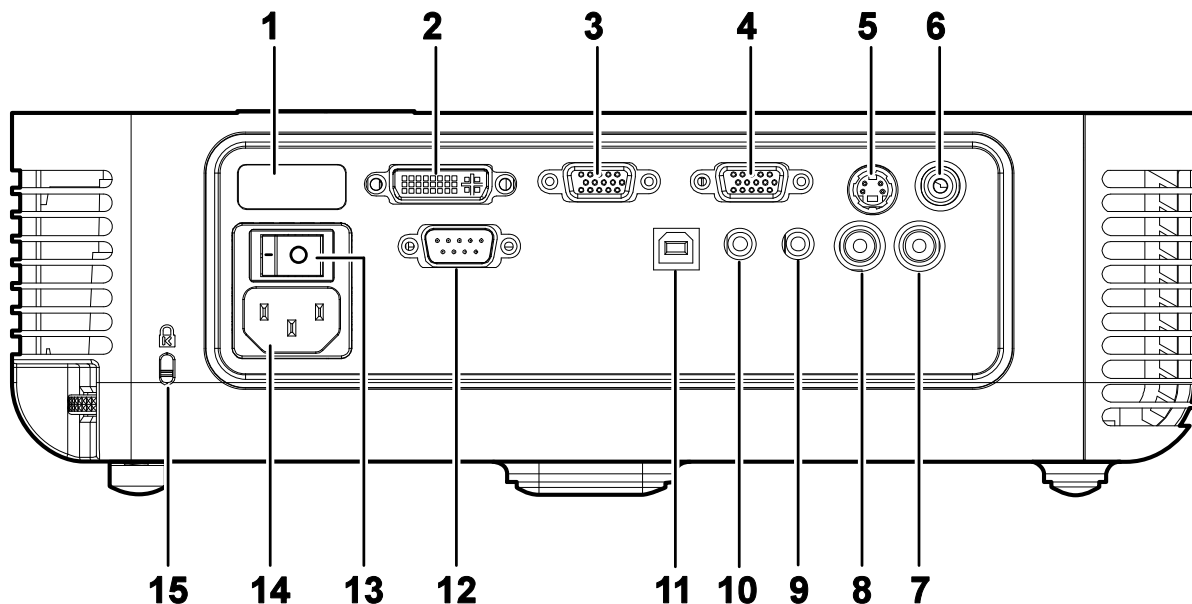

Item	Label	Description	See page:
1.	Rear IR receiver	Receiver for IR signal from remote control	7
2.	DVI-I	Connect a DVI-I cable (not supplied) from a computer	11
3.	VGA IN	Connect a VGA cable (supplied) from a computer	
4.	VGA OUT	Connect to a monitor (not supplied)	
5.	S-video	Connect the S-video cable (not supplied) from a video device	
6.	Video	Connect a composite video cable (supplied) from a video device.	
7.	Audio in-R	Connect the audio cable (supplied) from an audio input device.	
8.	Audio in-L	Connect the audio cable (supplied) from an audio input device.	
9.	Audio-in	Connect an audio cable (supplied) from the computer’s audio-out connector.	
10.	Audio-out	Audio loop-thru	
11.	USB	Connect the USB cable (supplied) from a computer	
12.	RS-232	Installation control	

Item	Label	Description	See page:
13.	Power Switch	Turns the power on and off	13
14.	Power	Connect the power cord (supplied)	13
15.	Security Lock	Secure to permanent object with a Kensington® Lock system	40

**Note:**

*If your video equipment has both S-video and RCA jacks (composite video) connect to the S-video connector.*

*S-video provides a better quality signal.*

Bottom view

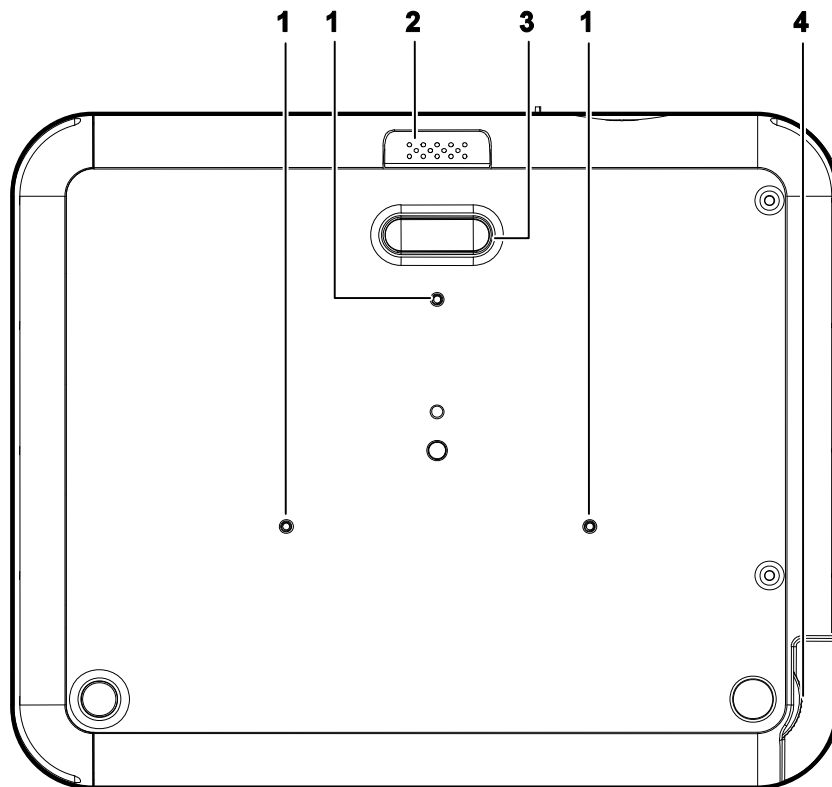

Item	Label	Description	See page:
1.	Ceiling support holes	Contact your dealer for information on mounting the projector on a ceiling.	
2.	Height adjuster button	Push to release height adjuster	<b>16</b>
3.	Height adjuster	Adjuster drops down when adjuster button is pushed	
4.	Tilt adjuster	Adjust angle of the picture	

**Note:**  
 When installing, ensure that you use only UL Listed ceiling mounts.

Remote Control Parts

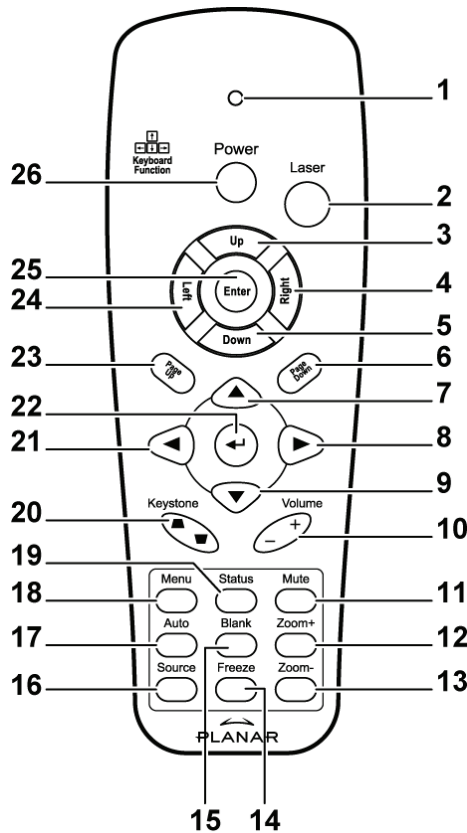

**Important:**

1. Avoid using the projector with bright fluorescent lighting turned on. Certain high-frequency fluorescent lights can disrupt remote control operation.

2. Be sure nothing obstructs the path between the remote control and the projector. If the path between the remote control and the projector is obstructed, you can bounce the signal off certain reflective surfaces such as projector screens.

3. The buttons and keys on the projector have the same functions as the corresponding buttons on the remote control. This user’s manual describes the functions based on the remote control.

Item	Label	Description	See page:
1.	Status LED	Lights when the remote control is used	
2.	Laser	Use as on screen pointer. DO NOT POINT IN EYES.	
3.	Up	Up arrow when connected through USB to a PC	
4.	Right	Right arrow when connected through USB to a PC	
5.	Down	Down arrow when connected through USB to a PC	
6.	Page Down	Page down when connected through USB to a PC	
7.	Up cursor	Navigates and changes settings in the OSD	<b>18</b>

<b>Item</b>	<b>Label</b>	<b>Description</b>	<b>See page:</b>
<b>8.</b>	Right cursor	Navigates and changes settings in the OSD	<b>18</b>
<b>9.</b>	Down cursor		
<b>10.</b>	Volume +/-	Adjusts volume	<b>17</b>
<b>11.</b>	Mute	Mutes the built-in speaker	
<b>12.</b>	Zoom+	Zoom in	
<b>13.</b>	Zoom-	Zoom out	
<b>14.</b>	Freeze	Freeze/unfreezes the on-screen picture	
<b>15.</b>	Blank	Makes the screen blank	
<b>16.</b>	Source	Detects the input device	
<b>17.</b>	Auto	Auto adjustment for phase, tracking, size, position	
<b>18.</b>	Menu	Opens the OSD	<b>18</b>
<b>19.</b>	Status	Opens the OSD Status menu (the menu only opens when an input device is detected)	
<b>20.</b>	Keystone top/bottom	Corrects image-trapezoid (wider top/bottom) effect	<b>17</b>
<b>21.</b>	Left cursor	Navigates and changes settings in the OSD	<b>18</b>
<b>22.</b>	Enter	Changes settings in the OSD	
<b>23.</b>	Page Up	Page up when connected through USB to a PC	
<b>24.</b>	Left	Left arrow when connected through USB to a PC	
<b>25.</b>	Enter	Enter key when connected through USB to a PC	
<b>26.</b>	Power	Turns the projector on or off	<b>13</b>

**Note:**

*The remote control can only interface with a computer when connected to the computer through a USB cable connection. The computer cable connects a computer to the projector for display purposes only.*



## Remote Control Operating Range

The remote control uses infrared transmission to control the projector. It is not necessary to point the remote directly at the projector. Provided you are not holding the remote perpendicular to the sides or the rear of the projector, the remote will function well within a radius of about 10 meters (33 feet) and 30 degrees above or below the projector level. If the projector does not respond to the remote control, move a little closer.

## Projector and Remote Control Buttons

The projector can be operated using the remote control or the buttons on the top of the projector. All operations can be carried out with the remote control; however the buttons on the projector are limited in use. The following illustration shows the corresponding buttons on the remote control and on the projector.

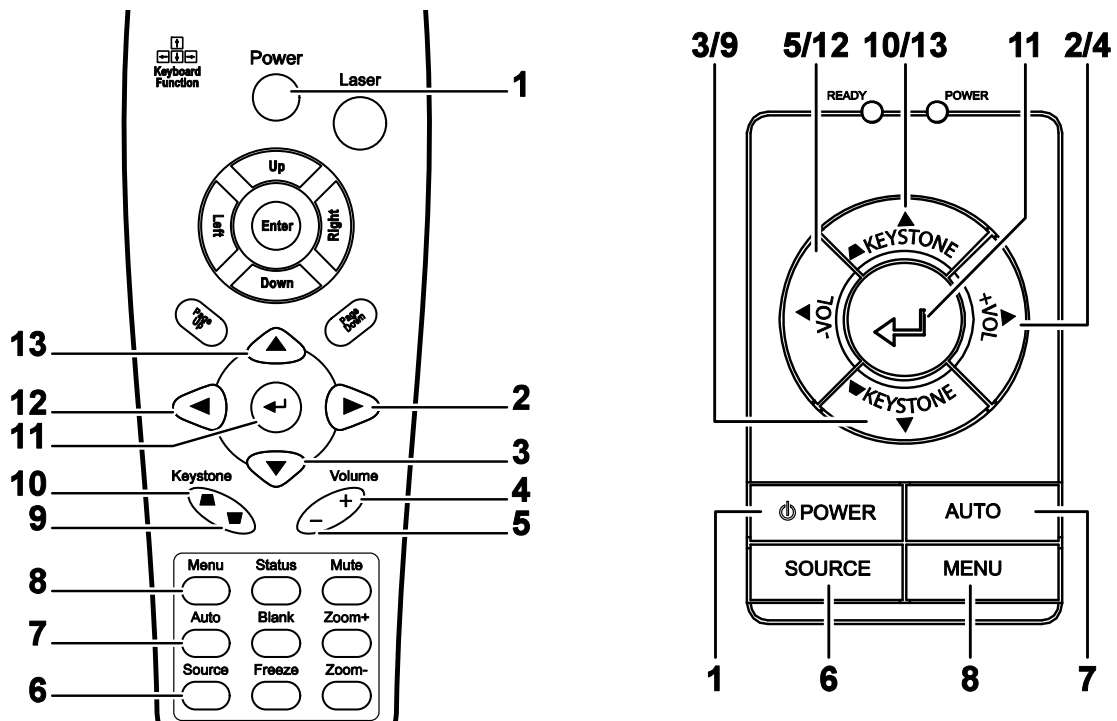

Some buttons on the projector have two functions. For example, item 10/13 on the projector functions both keystone button and as the up cursor key in OSD menus.

## Inserting the Remote Control Batteries

1. Remove the battery compartment cover by sliding the cover in the direction of the arrow.

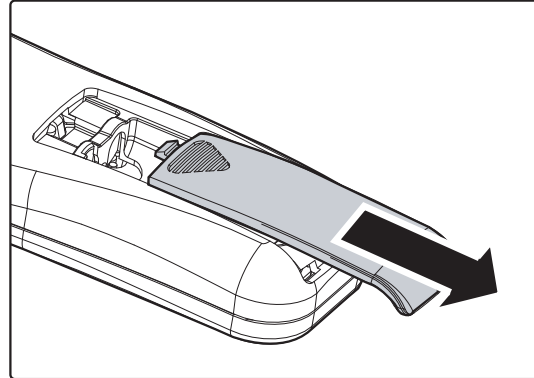

2. Insert the supplied batteries taking note of the polarity (+/-) as shown here.

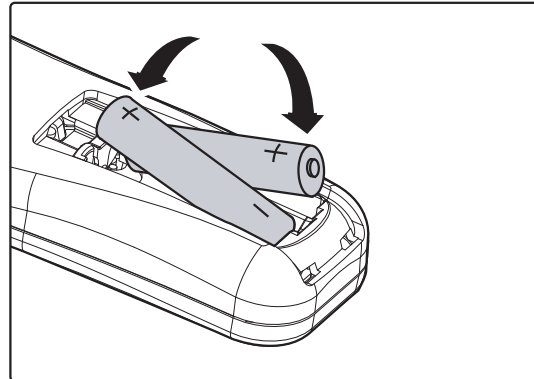

3. Replace the cover.

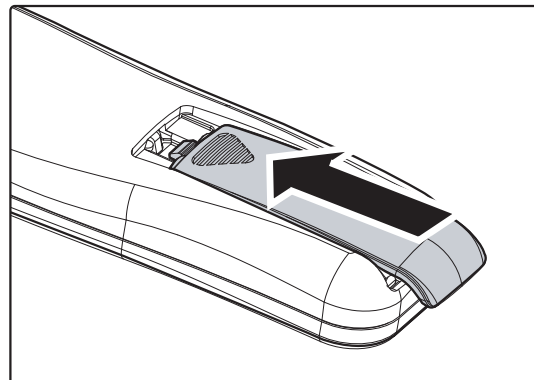

**Caution:**

1. Only use AAA batteries. (Alkaline is better)
2. Dispose of used batteries according to local ordinance regulations.
3. Remove the batteries when not using the projector for prolonged periods.

## Connecting Input Devices

A PC or notebook computer as well as video devices can be connected to the projector at the same time. Video devices include DVD, VCD, and VHS players, as well as movie camcorders and digital still cameras. Check the user manual of the connecting device to confirm it has the appropriate output connector.

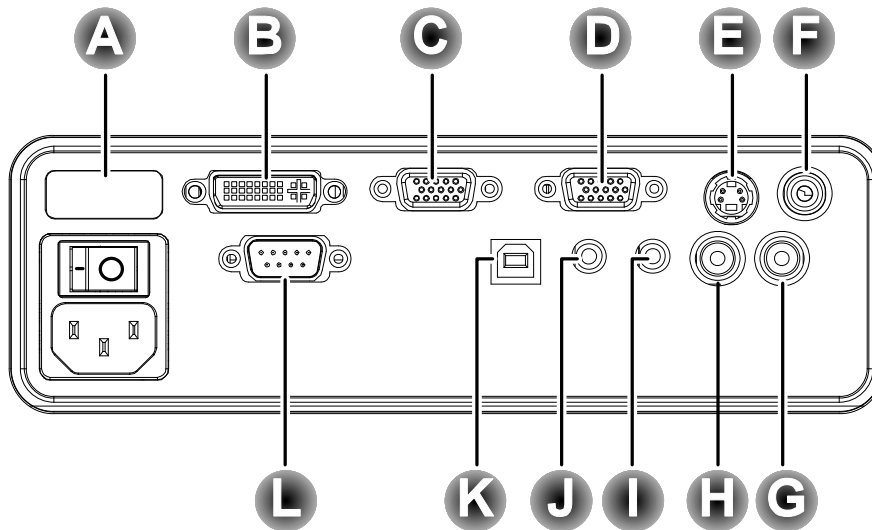

Item	Label	Description
A	Rear IR	Receiver for IR signal from remote control.
B	DVI-I	Connect DVI-I cable (not supplied) from a computer.
C	VGA in	Connect a VGA cable (supplied) from a computer.
D	VGA out	Connect a VGA cable (not supplied) to a monitor.
E	S-video	Connect S-video cable (not supplied) from a video device.
F	Video	Connect a composite video cable (supplied) from a video device.
G	Audio in-R	Connect the audio cable (supplied) from an audio input device.
H	Audio in-L	Connect the audio cable (supplied) from an audio input device.
I	Audio-in	Connect an audio cable (supplied) from the computer’s audio-out connector.

Item	Label	Description
J	Audio-out	Audio loop-thru
K	USB	Connect the supplied USB cable (supplied) from a computer for USB mouse function and firmware upgrades.
L	RS-232	Reserved for installation control.

**Warning:**

*As a safety precaution, disconnect all power to the projector and connecting devices before making connections.*

## Starting and Shutting down the Projector

1. Slide the lens cover.
2. Connect the power cord to the projector  
**[A]** Connect the other end to a wall outlet.  
 Switch **[B]** from off (**O**) to on (**—**)
3. The POWER and READY LEDs on the projector turn on.  
 Turn on the connected devices.
4. Ensure the Ready LED is on a steady (not flashing) orange and then press the **Power** button to turn on the projector.

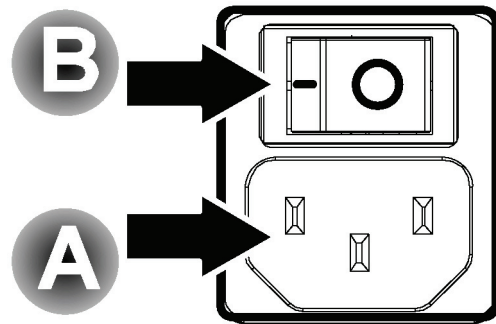

The projector splash screen displays and connected devices are detected. If the connected device is a PC, press the appropriate keys on the computer keyboard to switch the display output to the projector. (Check the user manual of the PC to determine the appropriate Fn key combination to change display output.)



See “Setting an Access Password (Security Lock)” on page 15 if Security Lock is enabled.

5. If more than one input device is connected, press the **Source** button to switch among devices (DVD and HDTV are supported through the VGA connector).

Source	Description
--------	-------------

RGB: Analog RGB  
 Component: DVD input YCbCr / YPbPr , or HDTV input YPbPr via HD15 connector

Composite Video: Traditional composite video

S-Video: Super video (Y/C separated)

DVI: Analog RGB , DVI



6. When the “Power Off?/Press Power again” message appears, press the **Power** button. The projector turns off.

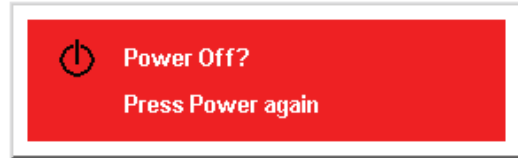

7. Turn off the main **Power** switch when the **Ready** LED stops flashing.

**Caution:**

*Do not unplug the power cord until the Ready LED stops flashing, indicating the projector has cooled down.*

## Setting an Access Password (Security Lock)

You can use the cursor (arrow) buttons to set a password and prevent unauthorized use of the projector. When enabled, the password must be entered after you power on the projector. (See “Navigating the OSD” on page 18 and “Setting the OSD Language” on page 19 for help on using OSD menus.)

**Important:**

*Keep the password in a safe place. Without the password, you will not be able to use the projector. If you lose the password, contact your reseller for information on clearing the password.*

1. Press the **Menu** button to open the OSD menu.

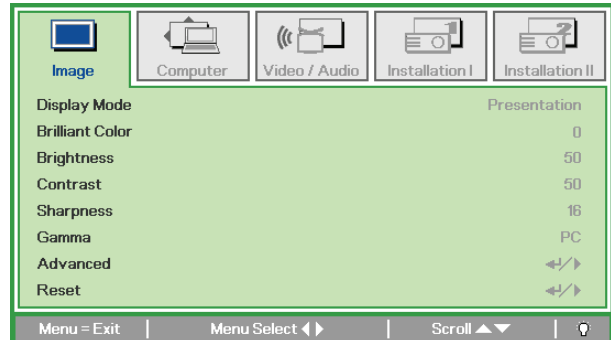

2. Press the cursor ◀▶ button to move to the **Installation I** menu. Press the cursor ▼▲ button to move to the Security Lock.

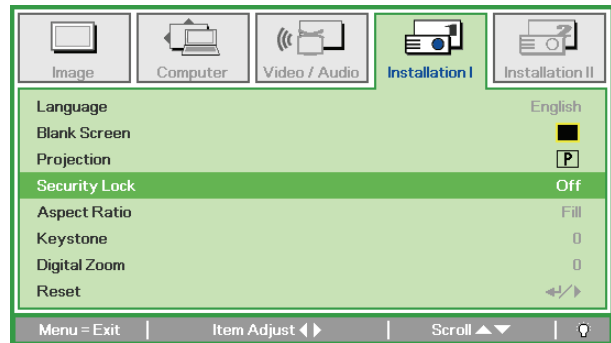

3. Press the cursor ◀▶ button to enable or disable security lock function. A password dialog box automatically appears.

4. You can only use the following four cursor buttons: ▼▲◀▶ in the password fields. You can use any combination including the same arrow five times, but not less than five. Press the cursor buttons in any order to set the password. When you confirm the password, **OK** appears.

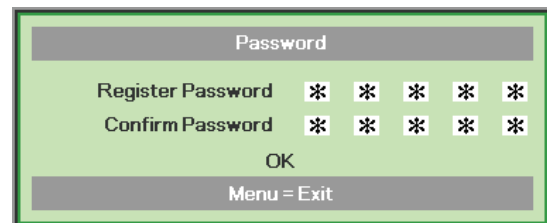

Every time you start the projector, a password dialog box appears.

Enter the password in the order you set it on step 4. (Press the **Menu** button to cancel if you enter the wrong password.)

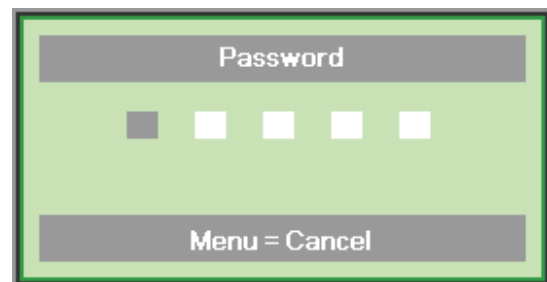

## Adjusting the Projector Level

Take note of the following when setting up the projector:

- *The projector table or stand should be level and sturdy.*
- *Position the projector so that it is perpendicular to the screen.*
- *Be sure cables are not in the way or can cause the projector to be knocked over.*

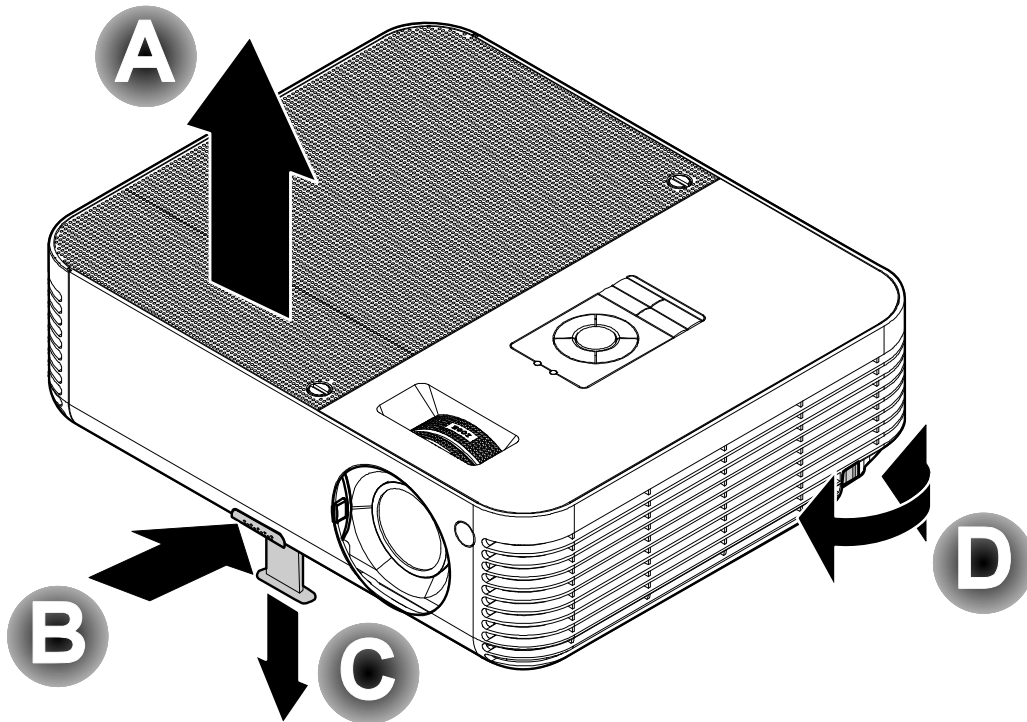

- 1.** To raise the level of the projector, lift the projector **[A]** and press the height-adjuster button **[B]**.

The height adjuster drops down **[C]**.

- 2.** To lower the level of the projector, press the height-adjuster button and push down on the top of the projector.

- 3.** To adjust the angle of the picture, turn the tilt adjuster **[D]** right or left until desired angle has been achieved.



## Adjusting the Zoom, Focus and Keystone

1. Use the **Image-zoom** control (on the projector only) to resize the projected image and screen size **B**.
2. Use the **Image-focus** control (on the projector only) to sharpen the projected image **A**.

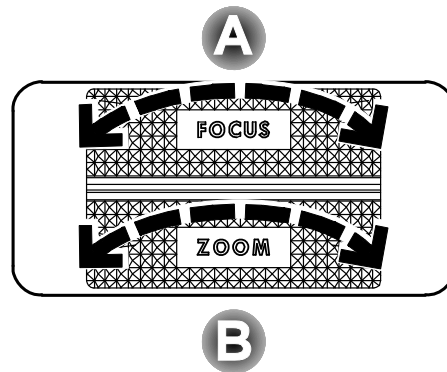

3. Press the **Keystone** button on the remote control or keypad. The keystone control appears on the display.

**Note:** When using the keypad, the OSD menu must be off.

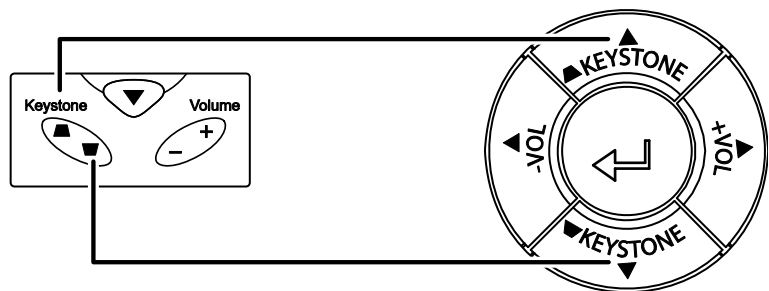

4. Use the **Keystone** button to correct image distortion.



## Adjusting the Volume

1. Press the **Volume +/-** button on the remote control or keypad. The volume control appears on the display.

**Note:** When using the keypad, the OSD menu must be off.

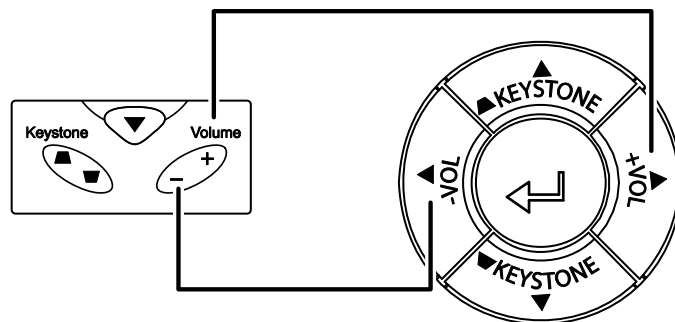

2. Use the **Volume +/-** button to adjust the level.



3. Press the **Mute** button to turn off the volume. (For remote only)



## On-Screen Display (OSD) Menu Settings

### OSD Menu Controls

The projector has an OSD that lets you make image adjustments and change various settings.

#### Navigating the OSD

You can use the remote control cursor buttons or the buttons on the top of the projector to navigate and make changes to the OSD. The following illustration shows the corresponding buttons on the remote control and on the projector.

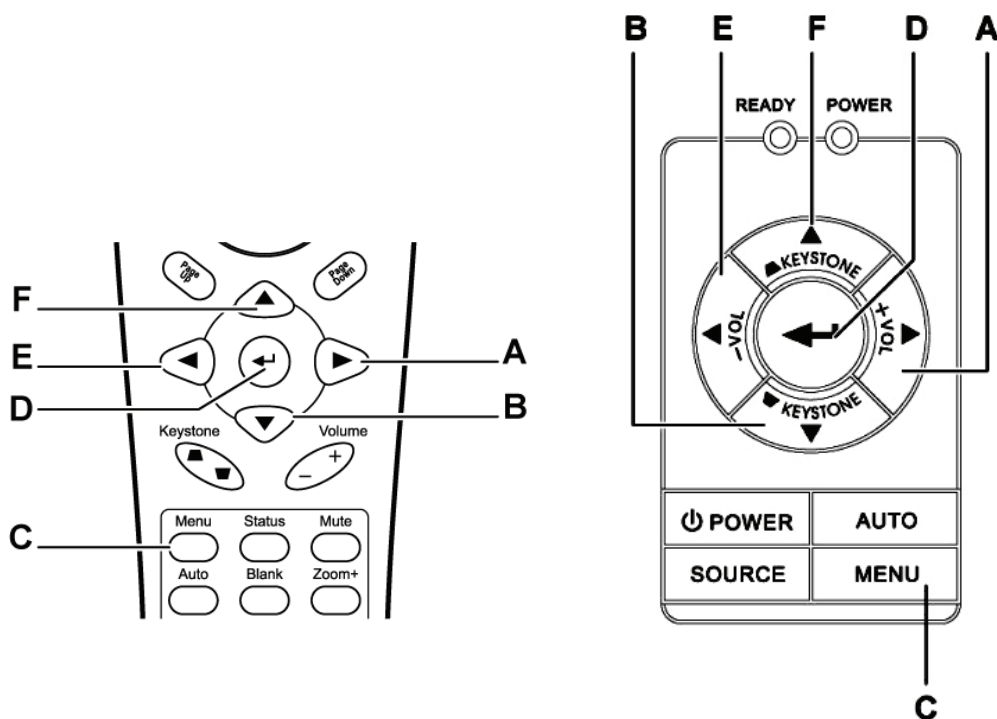

1. To open the OSD, press the **Menu** button.
2. There are five menus. Press the cursor ◀▶ button to move through the menus.
3. Press the cursor ▼▲ button to move up and down in a menu.
4. Press ◀▶ to change values for settings.
5. Press **Menu** to close the OSD or leave a submenu.

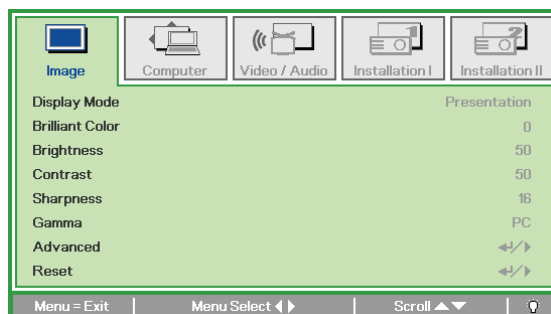

**Note:**

Depending on the video source not all items in the OSD are available. For example, the **Horizontal/Vertical Position** items in the **Computer** menu can be modified when connected to a PC. Items that are not available cannot be accessed and are grayed out.

## Setting the OSD Language

You may want to reference the OSD on your projector while reading this section. Set the OSD language to your preference before continuing. (The default language is English.)

1. Press the **Menu** button. Press the cursor ◀▶ button to navigate to **Installation I**.

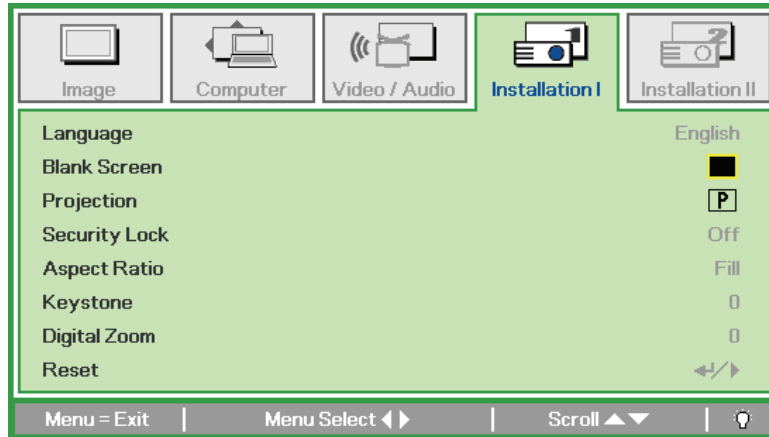

2. Press the cursor ▼▲ button until **Language** is highlighted.

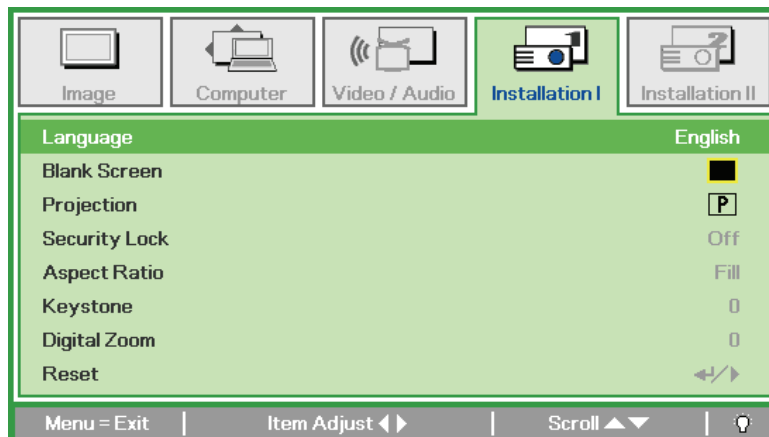

3. Press the ◀▶ button until your language is displayed.
4. Press the **Menu** button to close the OSD.

## OSD Menu Overview

Use the following illustration to quickly find a setting or determine the range for a setting.

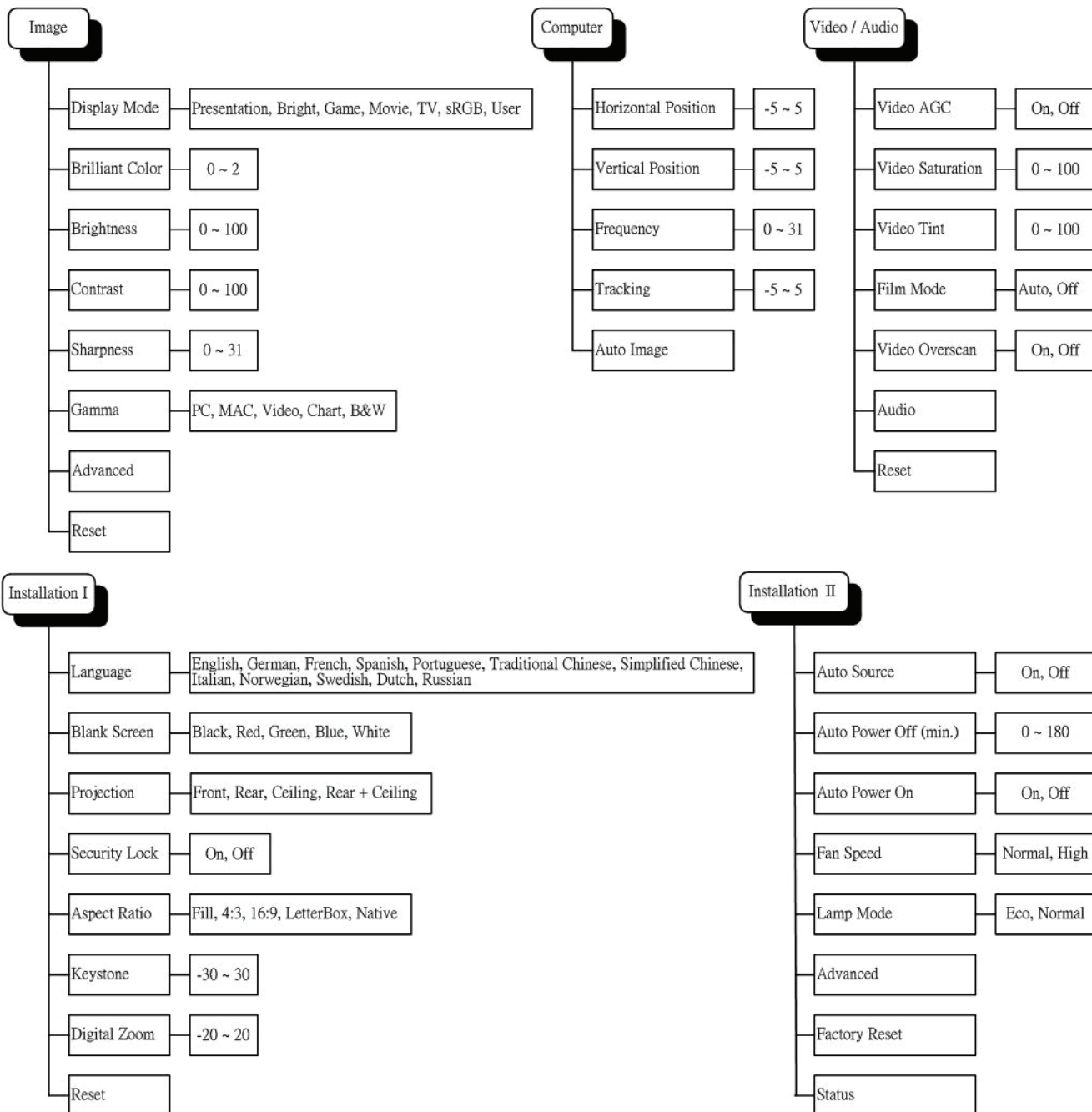

OSD Sub-Menu Overview

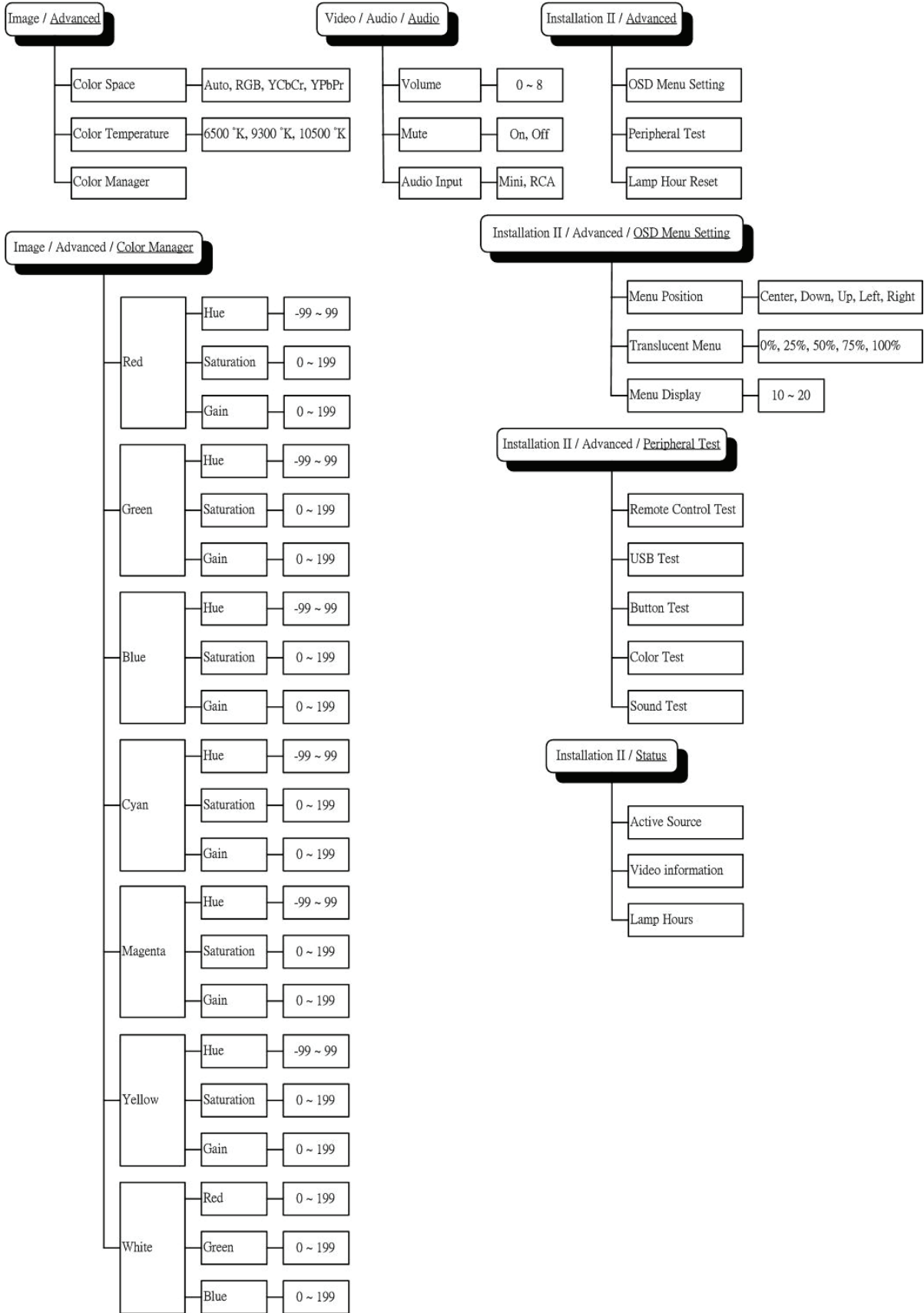

## Image Menu

Press the **Menu** button to open the **OSD** menu. Press the cursor ◀▶ button to move to the **Image** menu. Press the cursor ▲▼ button to move up and down in the **Image** menu. Press ◀▶ to change values for settings.

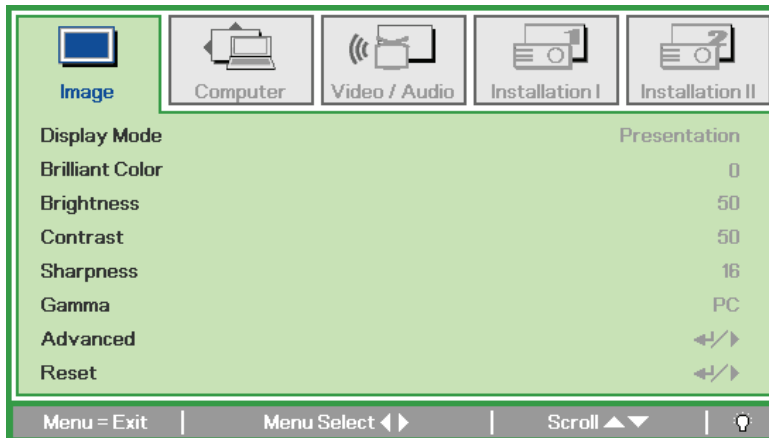

Item	Description
Display Mode	Press the cursor ◀▶ button to set the display mode. Source: Presentation, Bright, Game, Movie, TV, sRGB, User
Brilliant Color	Press the cursor ◀▶ button to adjust the Brilliant Color value. (Range: 0-2) Brilliant Color provides brighter, truer and more vibrant color. A higher setting provides a stronger enhanced image. (Range: 0 ~ 2)
Brightness	Press the cursor ◀▶ button to adjust the brightness. (Range: 0 – 100)
Contrast	Press the cursor ◀▶ button to adjust the contrast. (Range: 0 – 100)
Sharpness	Press the cursor ◀▶ button to adjust the display sharpness (Range: 0-31)
Gamma	Press the cursor ◀▶ button to adjust the gamma correction of the display. Range: PC, MAC, Video, Chart, B&W
Advanced	Press <b>Enter</b> / ▶ to enter the Advanced menu. See “Advanced Feature” on page 24.
Reset	Resets all <b>Image</b> settings to default values

Image Menu Functions Available for Connected Source

Function	RGB	Component Video	Composite Video	S-video	DVI
Display Mode	x	x	x	x	x
Brilliant Color	x	x	x	x	x
Brightness	x	x	x	x	x
Contrast	x	x	x	x	x
Sharpness	x	x	x	x	x
Gamma	x	x	x	x	x
Advanced	x	x	x	x	x
Reset	x	x	x	x	x

x = available to video source

### Advanced Feature

Press the **Menu** button to open the **OSD** menu. Press ◀▶ to move to the **Image** menu. Press ▼▲ to move to the **Advanced** menu and then press **Enter** or ▶. Press ▼▲ to move up and down in the **Advanced** menu. Press ◀▶ to change values for settings.

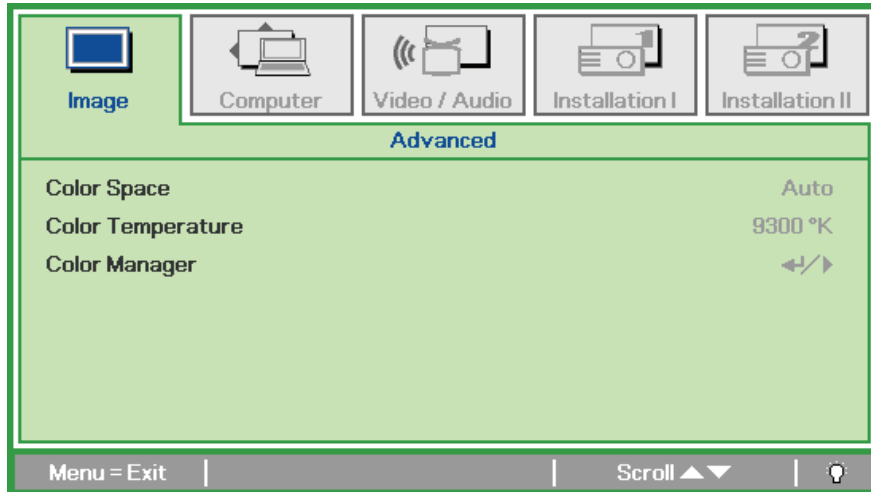

Item	Description
Color Space	Press the cursor ◀▶ button to adjust the color space. (Range: Auto – RGB – YPbPr- YCbCr)
Color Temperature	Press the cursor ◀▶ button to adjust the color temperature. (Range: 6500 °K ~ 10500 °K)
Color Manager	Press <b>Enter</b> / ▶ to enter the color manager menu. (Range: Red-Green-Blue-Cyan-Magenta-Yellow-White). See page 25 for more information on Color Manager.



*Color Manager*

Press Enter / ► to enter the color manager submenu.

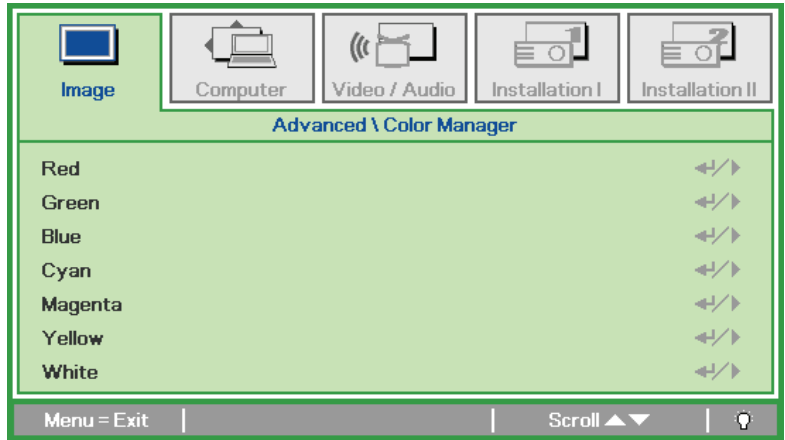

Item	Description
Red	Press <b>Enter</b> / ► button to adjust the red color level. Range: Hue (-99 ~ 99), Saturation (0 ~ 199), Gain (0 ~ 199)
Green	Press <b>Enter</b> / ► button to adjust the green color level. Range: Hue (-99 ~ 99), Saturation (0 ~ 199), Gain (0 ~ 199)
Blue	Press <b>Enter</b> / ► button to adjust the blue color level. Range: Hue (-99 ~ 99), Saturation (0 ~ 199), Gain (0 ~ 199)
Cyan	Press <b>Enter</b> / ► button to adjust the cyan color level. Range: Hue (-99 ~ 99), Saturation (0 ~ 199), Gain (0 ~ 199)
Magenta	Press <b>Enter</b> / ► button to adjust the magenta color level. Range: Hue (-99 ~ 99), Saturation (0 ~ 199), Gain (0 ~ 199)
Yellow	Press <b>Enter</b> / ► button to adjust the yellow color level. Range: Hue (-99 ~ 99), Saturation (0 ~ 199), Gain (0 ~ 199)
White	Press <b>Enter</b> / ► button to adjust the white color level. Range: Red (0 ~ 199), Green (0 ~ 199), Blue (0 ~ 199)

## Computer Menu

Press the **Menu** button to open the **OSD** menu. Press the cursor ◀▶ button to move to the **Computer** menu. Press the cursor ▲▼ button to move up and down in the **Computer** menu. Press ◀▶ to change values for settings.

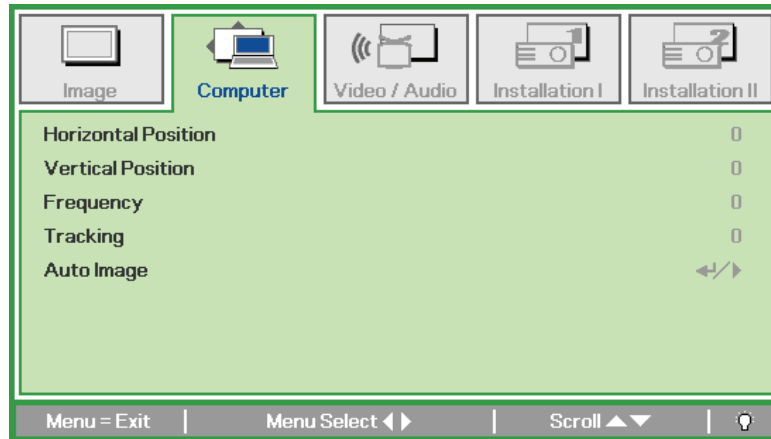

Item	Description
Horizontal Position	Press the cursor ◀▶ button to move the image left or right. (Range: -5 ~ +5)
Vertical Position	Press the cursor ◀▶ button to move the image up or down. (Range: -5 ~ +5)
Frequency	Press the cursor ◀▶ button to adjust the A/D sampling clock. (Range: Clock 0 ~ 31)
Tracking	Press the cursor ◀▶ button to adjust the A/D sampling number. (Range: -5 ~ +5)
Auto Image	Press Enter/ ▶ to Re-Sync source, adjustment for phase, tracking, size and position.

### Computer Menu Functions Available for Connected Source

Function	RGB	Component Video	Composite Video	S-video	DVI
H Position	x	x			
V Position	x	x			
Frequency	x	x			
Tracking	x	x			
Auto Image	x	x	x	x	x

x = available to video source

## Video/Audio Menu

Press the **Menu** button to open the **OSD** menu. Press the cursor ◀▶ button to move to the **Video/Audio** menu. Press the cursor ▲▼ button to move up and down in the **Video/Audio** menu. Press ◀▶ to change values for settings.

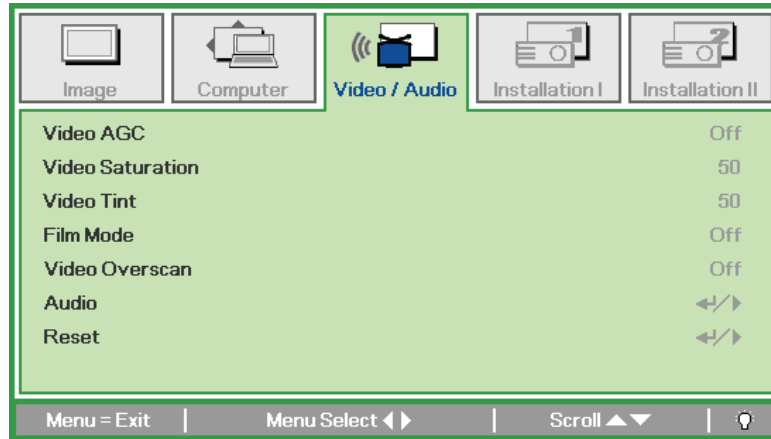

Item	Description
Video AGC	Press the cursor ◀▶ button to enable or disable automatic gain control for the video source. (Range: On – Off)
Video Saturation	Press the cursor ◀▶ button to adjust the video saturation. (Range: 0 – 100)
Video Tint	Press the cursor ◀▶ button to adjust the video tint/hue. (Range: 0 – 100)
Film Mode	Press the cursor ◀▶ button select different film mode. <ul style="list-style-type: none"> <li>• Off – Film mode is turned off.</li> <li>• Auto Automatic 2:2/3:2 pull-down detection. <ul style="list-style-type: none"> <li>○ 2:2 Uses 2:2 pull-down correction methods.</li> <li>○ 3:2 Uses 3:2 pull-down correction methods.</li> </ul> </li> </ul>
Video Overscan	Press the cursor ◀▶ button to enable or disable video over scan. (Range: On – Off)
Audio	Press <b>Enter</b> / ▶ to enter the Audio menu. See “Audio” on page 28.
Reset	Resets all <b>Video/Audio</b> settings to default values

Video/Audio Menu Functions Available for Connected Sources

Function	RGB	Component Video	Composite Video	S-video	DVI
Video AGC			x	x	
Video Saturation		x	x	x	
Video Tint		x	x	x	
Film Mode		x	x	x	
Video Overscan		x	x	x	
Audio	x	x	x	x	x
Reset	x	x	x	x	x

x = available to video source

Audio

Press Enter / ► to enter the audio submenu.

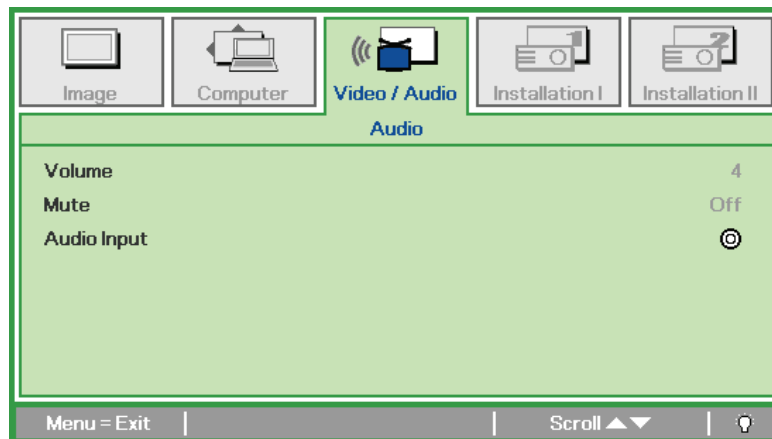

Item	Description
Volume	Press the cursor ◀▶ button to adjust the audio volume. (Range: 0 – 8)
Mute	Press the cursor ◀▶ button to turn on or off the speaker.
Audio Input	Press the cursor ◀▶ button to select audio input. (Range: Mini jack – RCA)

## Installation I Menu

Press the **Menu** button to open the **OSD** menu. Press the cursor ◀▶ button to move to the **Installation I** menu. Press the cursor ▲▼ button to move up and down in the **Installation I** menu. Press ◀▶ to change values for settings.

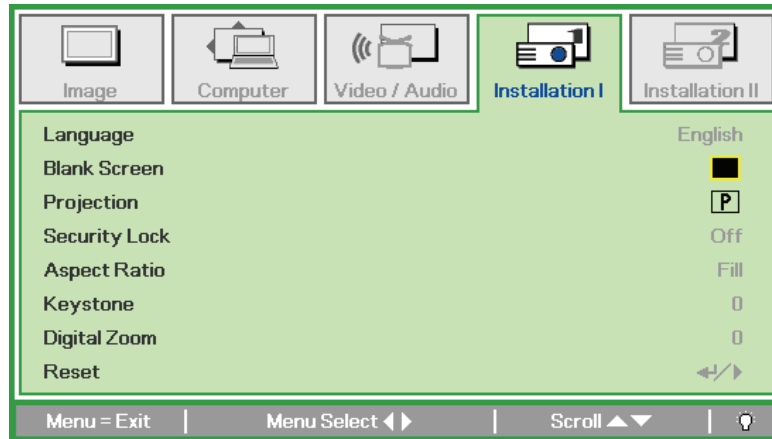

Item	Description
Language	Press the cursor ◀▶ to select the desired language. (Range: English, French, Dutch, German, Italian, Portuguese, Norwegian, Spanish, Swedish, Simplified Chinese, Traditional Chinese, Russian)
Blank Screen	Press the cursor ◀▶ button to select a background color for the blank screen. (Range: Black – Red – Green – Blue – White)
Projection	Press the cursor ◀▶ button to choose from four projection methods: <div style="display: flex; flex-direction: column; gap: 5px;"> <div><span style="border: 1px solid black; padding: 2px;">P</span> Desktop mount, front of screen</div> <div><span style="border: 1px solid black; padding: 2px;">Q</span> Desktop mount, rear of screen</div> <div><span style="border: 1px solid black; padding: 2px;">d</span> Ceiling mount, front of screen</div> <div><span style="border: 1px solid black; padding: 2px;">b</span> Ceiling mount, rear of screen</div> </div>
Security Lock	Press the cursor ◀▶ button to enable or disable security lock function.
Aspect Ratio	Press the cursor ◀▶ button to adjust the video aspect ratio. (Range: Fill, 4:3, 16:9, Letter Box, Native)
Keystone	Press the cursor ◀▶ button to adjust the keystone display. (Range: -30 ~ +30)
Digital Zoom	Press the cursor ◀▶ button to adjust the Digital Zoom menu. (Range: -20 ~ +20)
Reset	Resets all <b>Installation I</b> settings to default values

Installation I Menu Functions Available for Connected Sources

<b>Function</b>	<b>RGB</b>	<b>Component Video</b>	<b>Composite Video</b>	<b>S-video</b>	<b>DVI</b>
Language	x	x	x	x	x
Blank Screen	x	x	x	x	x
Projection	x	x	x	x	x
Security Lock	x	x	x	x	x
Aspect Ratio	x	x	x	x	x
Keystone	x	x	x	x	x
Digital Zoom	x	x	x	x	x
Reset	x	x	x	x	x

x = available to video source

## Installation II Menu

Press the **Menu** button to open the **OSD** menu. Press the cursor ◀▶ button to move to the **Installation II** menu. Press the cursor ▲▼ button to move up and down in the **Installation II** menu. Press ◀▶ to change values for settings.

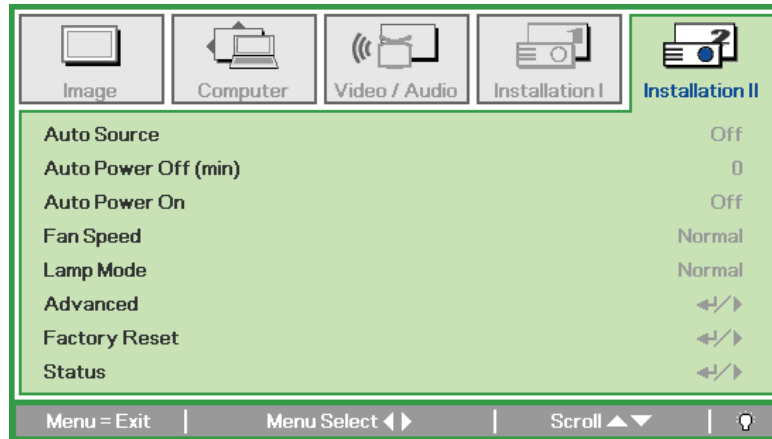

Item	Description
Auto Source	Press the cursor ◀▶ button to enable or disable automatic source detection. (Range: On – Off)
Auto Power Off (min)	Press the cursor ◀▶ button to enable or disable automatic shutdown of lamp after a set number of minutes. (Range: 0 ~ 180)
Auto Power On	Press the cursor ◀▶ button to enable or disable automatic power on when AC power is supplied. (Range: On ~ Off)
Fan Speed	Press the cursor ◀▶ button to toggle between normal and high fan speed. Set Fan Speed to High in altitudes over 1500 meters (5000 feet).
Lamp Mode	Press the cursor ◀▶ button to choose the lamp mode. Range: Eco and Normal. Eco mode uses less power and extends lamp life, but decreases lamp brightness. Normal mode uses more power and reduces lamp life, but increases lamp brightness.
Advanced	Press <b>Enter</b> / ▶ to enter the Advanced menu. See “Advanced Feature” on page 32.
Factory Reset	Press <b>Enter</b> / ▶ to reset all items to factory preset values.
Status	Press <b>Enter</b> / ▶ to view the current display status (these items are display only). See “Status” on page 34.

### Advanced Feature

Press the **Menu** button to open the **OSD** menu. Press **◀▶** to move to the **Installation II** menu. Press **▲▼** to move to the **Advanced** menu and then press **Enter** or **▶**. Press **▲▼** to move up and down in the **Advanced** menu. Press **◀▶** to change values for settings.

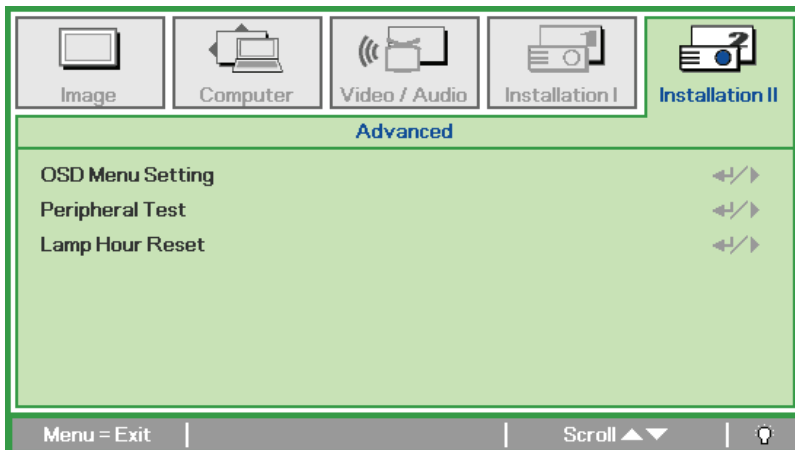

Item	Description
OSD Menu Setting	Press Enter / ▶ to enter the OSD setting menu.
Peripheral Test	Press Enter/ ▶ to enter the Peripheral Test menu. (Range: Remote Control, USB, Button, Color and Sound test)
Lamp Hour Reset	After replacing the lamp, this item should be reset. See “Resetting the Lamp” on page 38.

#### OSD Menu Setting

Press **Enter** or **▶** to enter the OSD Menu Setting menu.

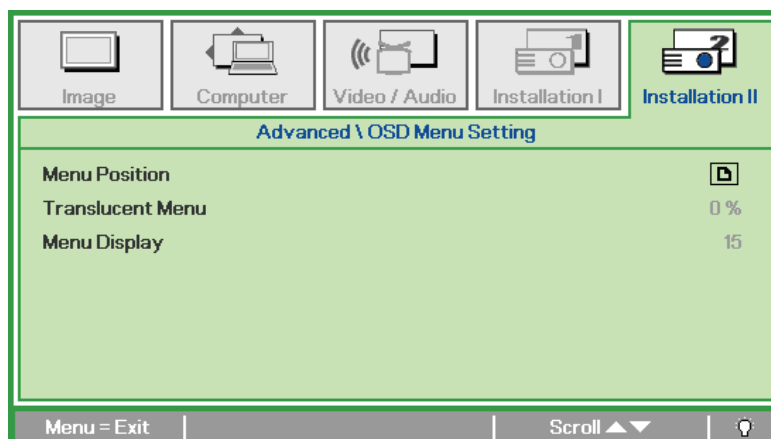

Item	Description
Menu Position	Press to position the OSD on screen (Range: Center, Down, Up, Left, Right)



Item	Description
Translucent Menu	Press ◀▶ to set menu screen translucency (Range: 0%, 25%, 50%, 75%, 100%)
Menu Display	Press ◀▶ to determine timeout delay of OSD (Range: 10 - 20 sec.)

*Peripheral Test*

Press **Enter** or ▶ to enter the Peripheral Test menu.

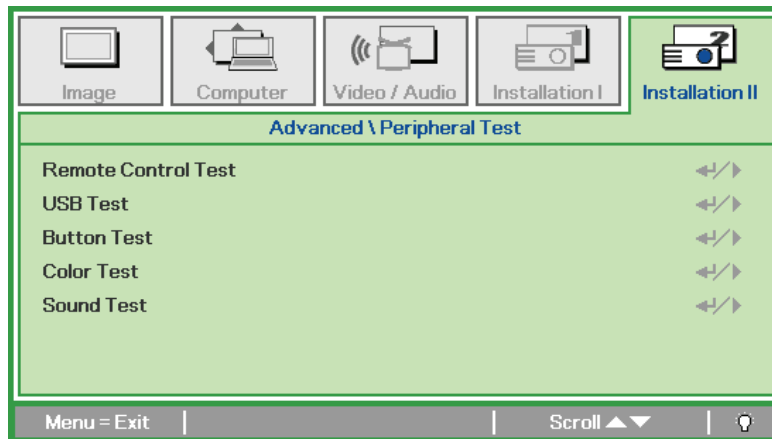

Item	Description
Remote Control Test	Press Enter or ▶ and follow the on-screen prompts to carry out the Remote Control Test. Press the <b>Menu</b> button twice to return to the Peripheral Test menu.
USB Test	Press Enter or ▶ and follow on-screen prompts to carry out the USB Test. Press the <b>Menu</b> button to return to the Peripheral Test menu.
Button Test	Press Enter or ▶ and follow the on-screen prompts to carry out the Button (display panel) Test. Press the <b>Menu</b> button twice to return to the Peripheral Test menu.
Color Test	Press Enter or ▶ and follow on-screen prompts to carry out the Color Test. Press the <b>Menu</b> button to return to the Peripheral Test menu.
Sound Test	Press Enter or ▶ and follow on-screen prompts to carry out the Sound Test. Press the <b>Menu</b> button to return to the Peripheral Test menu.

Status

Press the **Menu** button to open the **OSD** menu. Press ◀▶ to move to the **Installation II** menu. Press ▲▼ to move to the **Status** menu and then press **Enter** or ▶.

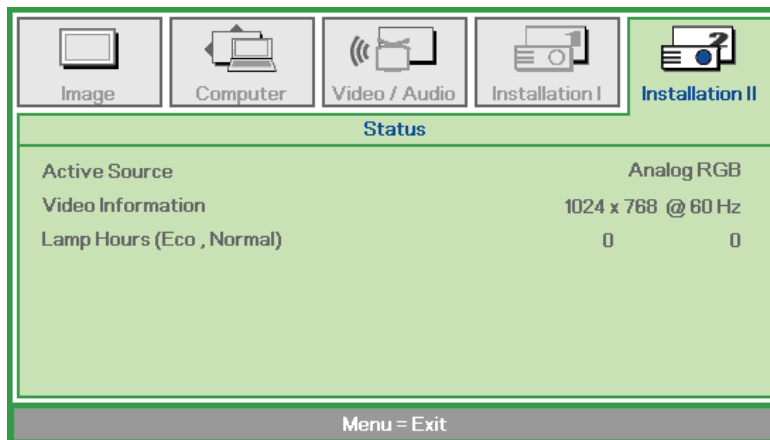

Item	Description
Active Source	Displays the active source.
Video Information	Displays the resolution and refresh rate for RGB mode. Displays the color standard for video mode.
Lamp Hours (Eco, Normal)	Shows the number of hours the lamp has been in use for Eco and Normal modes.

# Maintenance and Security

## Replacing the Projection Lamp

The projection lamp should be replaced when it burns out. It should only be replaced with a certified replacement part, which you can order from your local dealer.

**Important:**

1. The lamp contains a certain amount of mercury and should be disposed of according to local ordinance regulations.
2. Avoid touching the glass surface of the new lamp: Doing so may shorten its operation life.

**Warning:**

Be sure to turn off and unplug the projector at least an hour before replacing the lamp. Failure to do so could result in a severe burn.

**Note:**

Safety glasses should be worn when replacing the lamp while the projector is ceiling mounted.

1. Loosen the two captive screws on the lamp compartment cover (A).

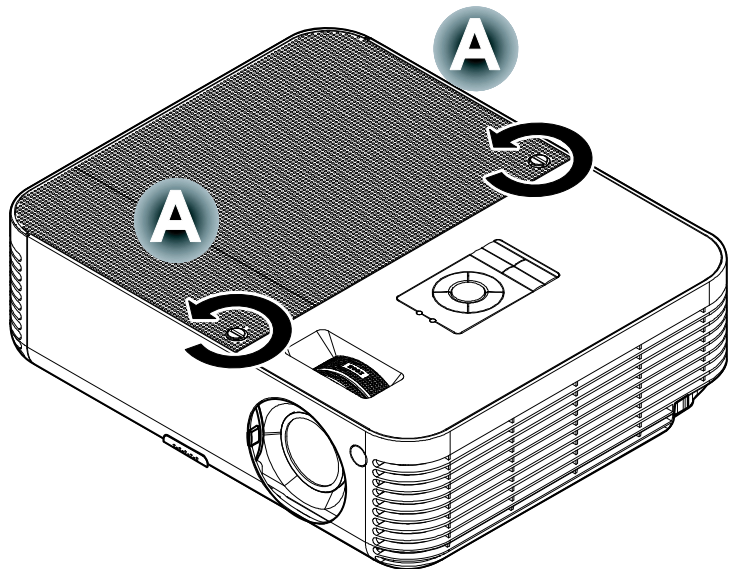

- 2.** Open the lamp compartment cover (B).

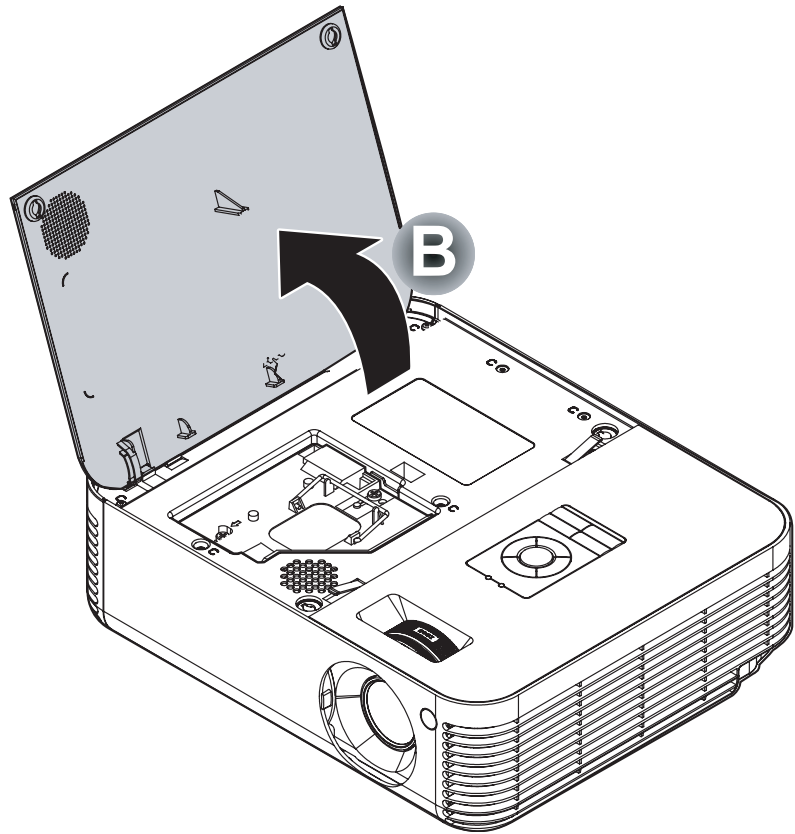

- 3.** Remove the two screws from the lamp module (C).

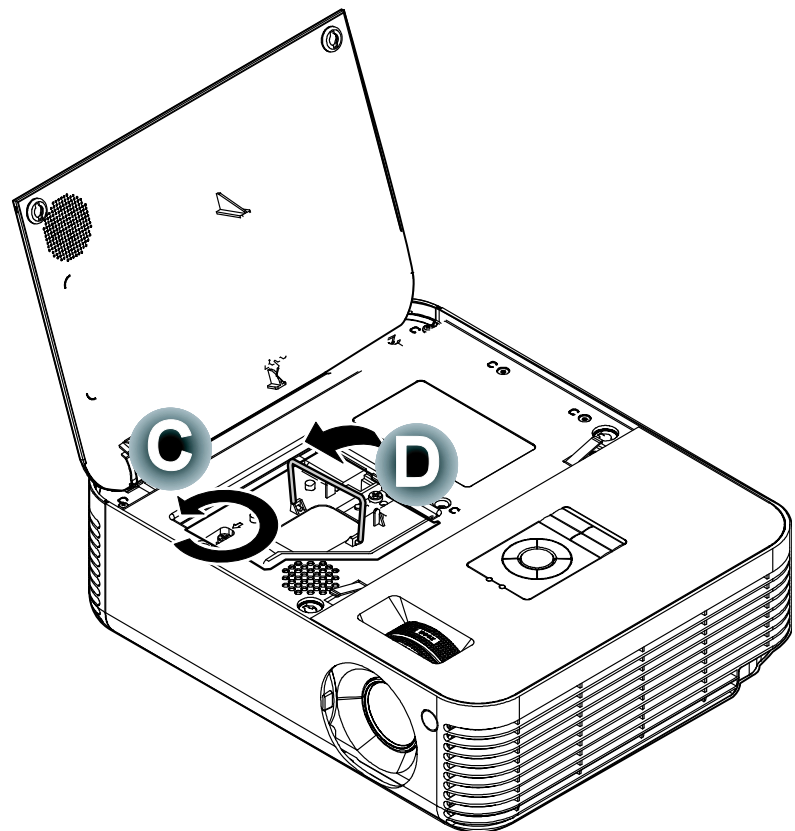

- 4.** Lift the module handle up (D).

- 5.** Pull firmly on the module handle to remove the lamp module (D)

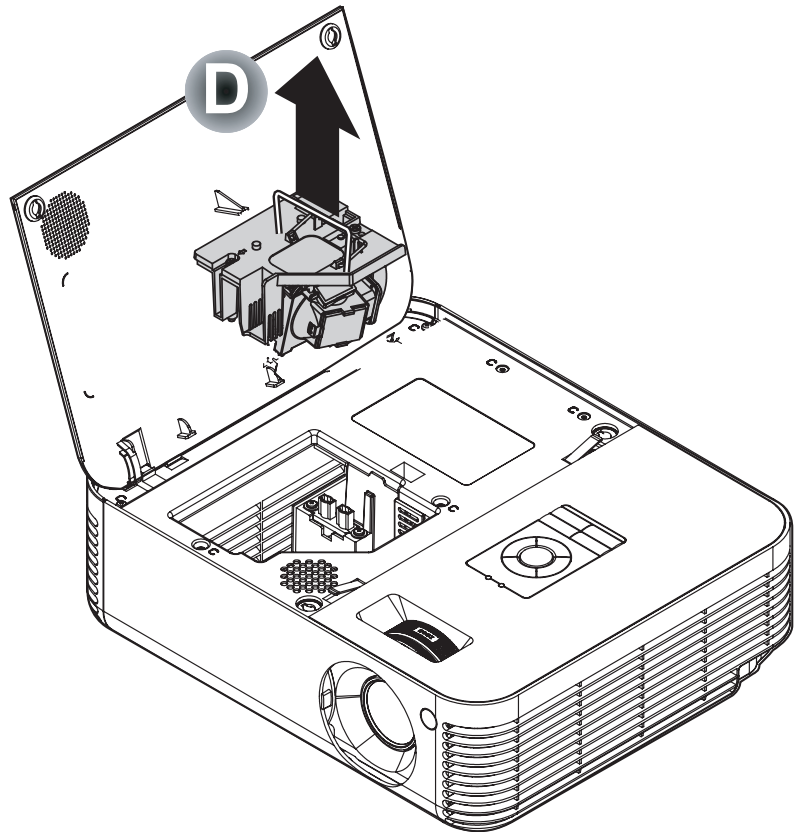

- 6.** Reverse steps 1 to 5 to install the new lamp module.

## Resetting the Lamp

After replacing the lamp, you should reset the lamp hour counter to zero. Refer to the following:

1. Press the **Menu** button to open the **Image** menu.
2. Press the cursor ◀▶ button to move to the **Installation II** menu. Press the cursor ▲▼ button to move down to **Advanced**.

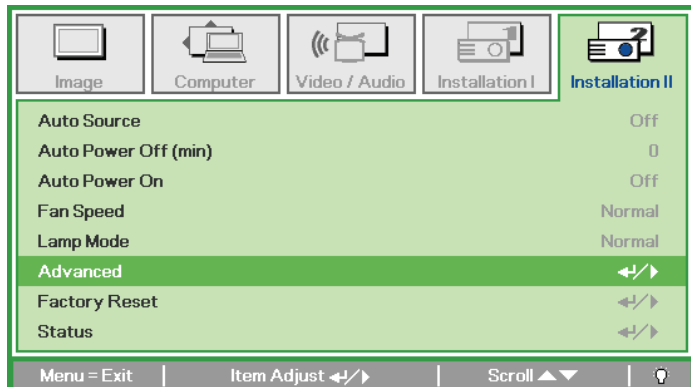

3. Press the cursor ▼▲ button to move down to **Lamp Hour Reset**.

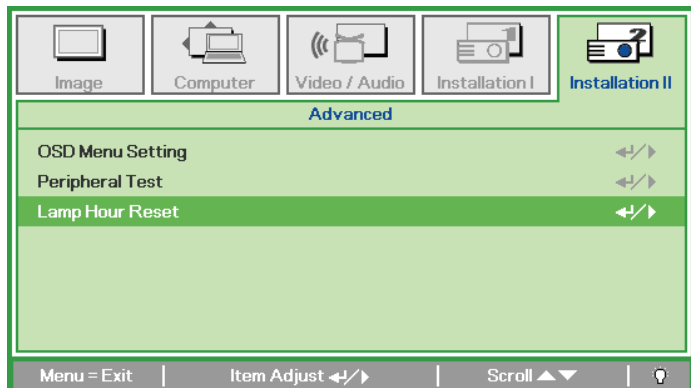

4. Press the cursor ▶ or **Enter** button.

A message screen appears.

5. Press the cursor buttons in this order: ▼▲◀▶. The **Lamp Hours** reset to zero.

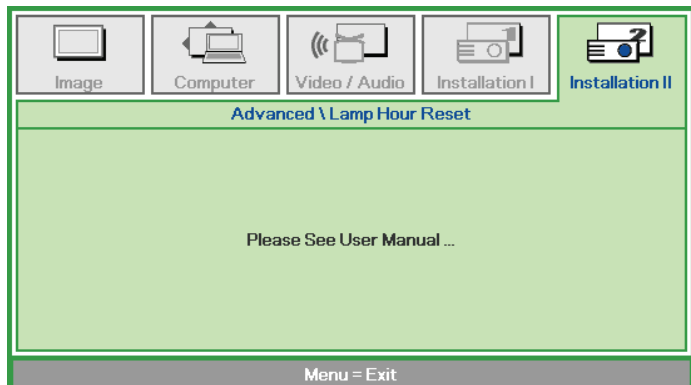

## Cleaning the Projector

Cleaning the projector to remove dust and grime will help ensure trouble-free operation.

**Warning:**

1. Be sure to turn off and unplug the projector at least an hour before cleaning. Failure to do so could result in a severe burn.
2. Use only a dampened cloth when cleaning. Do not allow water to enter the ventilation openings on the projector.
3. If a little water gets into the projector interior while cleaning, leave unplugged in a well-ventilated room for several hours before using.
4. If a lot of water gets into the projector interior when cleaning, have the projector serviced.

## Cleaning the Lens

You can purchase optic lens cleaner from most camera stores. Refer to the following to clean the projector lens.

1. Apply a little optic lens cleaner to a clean soft cloth. (Do not apply the cleaner directly to the lens.)
2. Lightly wipe the lens in a circular motion.

**Caution:**

1. Do not use abrasive cleaners or solvents.
2. To prevent discoloration or fading, avoid getting cleaner on the projector case.

## Cleaning the Case

Refer to the following to clean the projector case.

1. Wipe off dust with a clean dampened cloth.
2. Moisten the cloth with warm water and mild detergent (such as used to wash dishes), and then wipe the case.
3. Rinse all detergent from the cloth and wipe the projector again.

**Caution:**

To prevent discoloration or fading of the case, do not use abrasive alcohol-based cleaners.

## Using the Kensington® Lock

If you are concerned about security, attach the projector to a permanent object with the Kensington slot and a security cable.

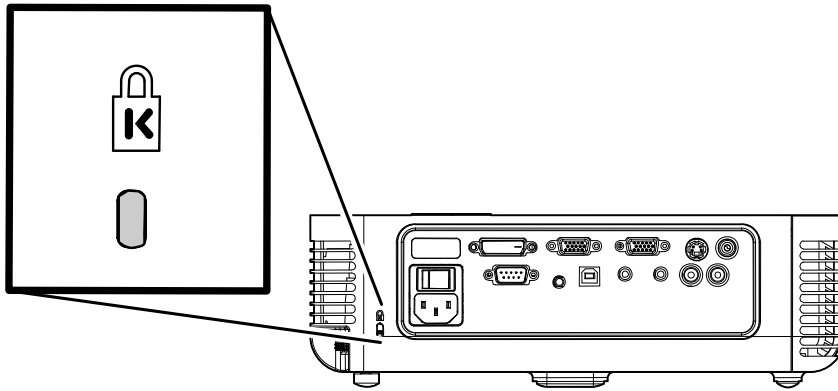

**Note:**

Contact your vendor for details on purchasing a suitable Kensington security cable.

The security lock corresponds to Kensington’s MicroSaver Security System. If you have any comment, contact: Kensington, 2853 Campus Drive, San Mateo, CA94403, U.S.A. Tel: 800-535-4242, <http://www.Kensington.com>.



## Common problems and solutions

These guidelines provide tips to deal with problems you may encounter while using the projector. If the problem remains unsolved, contact your dealer for assistance.

Often after time spent troubleshooting, the problem is traced to something as simple as a loose connection. Check the following before proceeding to the problem-specific solutions.

- *Use some other electrical device to confirm that the electrical outlet is working.*
- *Ensure the projector is turned on.*
- *Ensure all connections are securely attached.*
- *Ensure the attached device is turned on.*
- *Ensure a connected PC is not in suspend mode.*
- *Ensure a connected notebook computer is configured for an external display. (This is usually done by pressing an Fn-key combination on the notebook.)*

## Tips for Troubleshooting

In each problem-specific section, try the steps in the order suggested. This may help you to solve the problem more quickly.

Try to pin point the problem and thus avoid replacing non-defective parts. For example, if you replace batteries and the problem remains, put the original batteries back and go to the next step.

Keep a record of the steps you take when troubleshooting: The information may be useful when calling for technical support or for passing on to service personnel.

## LED Error Messages

Error code message	Power LED/flashes	Ready LED/flashes
Over temperature	3	0
Thermal Break	4	0
G794 fail	4	4
T1 fail	4	5
Lamp error	5	0
Ballast Over Temperature	5	1
Ballast short circuit in output detected	5	2
End of lamp lift detected	5	3
Ballast lamp did not ignite	5	4
Lamp extinguished during normal operation	5	5
Lamp extinguished during run-up phase	5	6
Fan1 error (Lamp Fan)	6	1
Fan2 error (Ballast Fan)	6	2
Fan3 error (Burner Fan)	6	3
Fan4 error (Power Fan)	6	4
Lamp door open	7	0
DMD error	8	0
Color wheel error	9	0

## Image Problems

***Problem: No image appears on the screen***

1. Verify the settings on your notebook or desktop PC.
2. Turn off all equipment and power up again in the correct order.

***Problem: The image is blurred***

1. Adjust the **Focus** on the projector.
2. Press the **Auto** button on the remote control or projector.
3. Ensure the projector-to-screen distance is within the 10-meter (33-feet) specified range.
4. Check that the projector lens is clean.

***Problem: The image is wider at the top or bottom (trapezoid effect)***

1. Position the projector so it is as perpendicular to the screen as possible.
2. Use the **Keystone** button on the remote control or projector to correct the problem.

***Problem: The image is reversed or upside down***

Check the **Projection** setting on the **Utility** menu of the OSD.

***Problem: The image is streaked***

1. Set the **Frequency** and **Tracking** settings on the **Utility** menu of the OSD to the default settings.

2. To ensure the problem is not caused by a connected PC's video card, connect to another computer.

***Problem: The image is flat with no contrast***

Adjust the **Contrast** setting on the **Main** menu of the OSD.

***Problem: The color of the projected image does not match the source image.***

Adjust the **Color Temperature** and **Gamma** settings on the **Main** menu of the OSD.

## Lamp Problems

***Problem: There is no light from the projector***

1. Check that the power cable is securely connected.
2. Ensure the power source is good by testing with another electrical device.
3. Restart the projector in the correct order and check that the Power LED is green.
4. If you have replaced the lamp recently, try resetting the lamp connections.
5. Replace the lamp module.
6. Put the old lamp back in the projector and have the projector serviced.

***Problem: The lamp goes off***

1. Power surges can cause the lamp to turn off. Press the power button twice to turn off the projector. When the Ready LED is on, press the power button.
2. Replace the lamp module.
3. Put the old lamp back in the projector and have the projector serviced.

## Remote Control Problems

***Problem: The projector does not respond to the remote control***

1. Direct the remote control towards remote sensor on the projector.
2. Ensure the path between remote and sensor is not obstructed.
3. Turn off any fluorescent lights in the room.
4. Check the battery polarity.
5. Replace the batteries.
6. Turn off other Infrared-enabled devices in the vicinity.
7. Have the remote control serviced.

## Audio Problems

***Problem: There is no sound***

1. Adjust the volume on the remote control.
2. Adjust the volume of the audio source.
3. Check the audio cable connection.
4. Test the source audio output with other speakers.
5. Have the projector serviced.

***Problem: The sound is distorted***

1. Check the audio cable connection.
2. Test the source audio output with other speakers.
3. Have the projector serviced.

# Specifications

## Input/output connectors

Connector	Description
Data in	DVI-I
	RGB HD-15
Data out	RGB HD-15
Video	Composite video (RCAX1)
	S-video
Audio in	Stereo RCAX2 (L+R)
	Stereo Mini-jack
Audio out	Stereo Mini-jack
Control	RS-232
	USB
Security	Kensington lock

**Projection Distance vs. Projection Size**

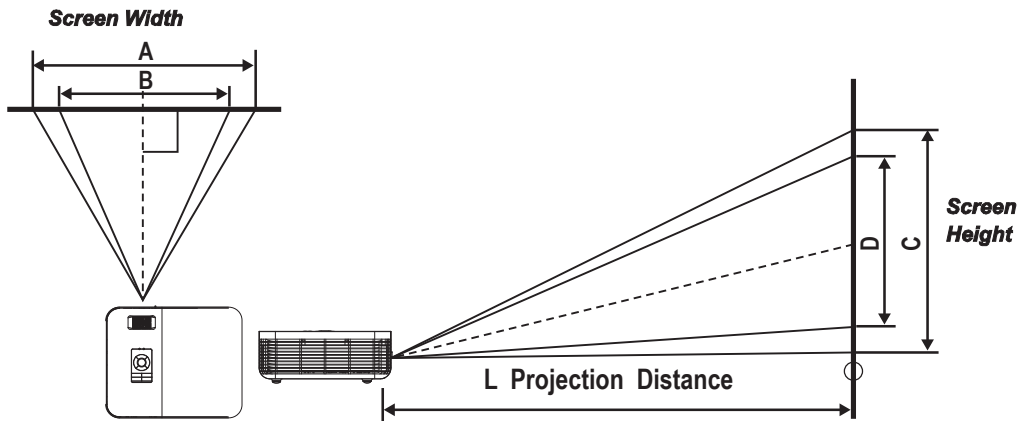

Projection distance and size table

Projection Distance L	Max. Screen Size (Wide)			Max. Screen Size (Tele)		
	Diagonal	Width A	Height C	Diagonal	Width B	Height D
1.5m	1.16m	0.99m	0.62m	1.01m	0.86m	0.54m
4.92'	46"	38.97"	24.4"	40"	33.85"	21.25"
2m	1.55m	1.32m	0.83m	1.35m	1.15m	0.72m
6.56'	61.4"	51.96"	32.67"	53.3"	45.27"	28.34"
3m	2.33m	1.99m	1.24m	2.032	1.72m	1.08m
9.84'	92"	78.34"	48.81"	80"	67.71"	42.51"
4m	3.12m	2.65m	1.66m	2.71m	2.3m	1.44m
13.12'	122.9"	104.33"	65.35"	106.73"	90.55"	56.69"
5m	3.9m	3.31m	2.07m	3.38m	2.87m	1.8m
16.4'	153.7"	130.31"	81.49"	133.4"	112.99"	70.86"
6m	4.68m	3.97m	2.48m	4.06m	3.45m	2.16m
19.68'	184.4"	156.29"	97.63"	160"	135.82"	85.03"
7m	5.46m	4.64m	2.9m	4.74m	4.02m	2.51m
22.96'	215.2"	182.67"	114.17"	186.78"	158.26"	98.81"
8m	6.24m	5.3m	3.31m	5.42m	4.6m	2.87m
26.24'	245.9"	208.66"	130.31"	213.4"	181.1"	112.99"
9m	7.02m	5.96m	3.73m	6.09m	5.17m	3.23m
29.52'	276.7"	234.64"	146.85"	240.1"	203.54"	127.16"
10m	7.8m	6.62m	4.14m	6.77m	5.75m	3.59m
32.8'	307.4"	260.62"	162.99"	266.8"	226.37"	141.33"

*Shaded rows are equivalent measurement in feet and inches*

**Timing Mode Table**

The projector can display several resolutions. The following table outlines the resolutions that can be displayed by the projector.

Signal	Resolution	Frequency H. (KHz)	Frequency V. (Hz)	Video	Digital	Analog
NTSC	-	15.73	60.0	○	-	-
PAL/SECAM	-	15.62	50.0	○	-	-
VESA	640 x 350	37.9	85.1	-	○	○
	640 x 400	37.9	85.1	-	○	○
	720 x 400	37.9	85.0	-	○	○
	640 x 480	31.5	60.0	-	○	○
	640 x 480	37.9	72.8	-	○	○
	640 x 480	37.5	75.0	-	○	○
	640 x 480	43.3	85.0	-	○	○
	800 x 600	35.2	56.3	-	○	○
	800 x 600	37.9	60.3	-	○	○
	800 x 600	48.1	72.2	-	○	○
	800 x 600	46.9	75.0	-	○	○
	800 x 600	53.7	85.1	-	○	○
	1024 x 768	48.4	60.0	-	○	○
	1024 x 768	56.5	70.1	-	○	○
	1024 x 768	60.0	75.0	-	○	○
	1024 x 768	68.8	85.0	-	○	○
	1280 x 800	49.7	59.8	-	○	○
	1280 x 800	62.8	74.9	-	○	○
	1280 x 800	71.6	84.8	-	○	○
	1280 x 1024	64	60	-	○	○
	1280 x 1024	80	75	-	○	○
	1280 x 1024	91.1	85	-	○	-
	1400 x 1050	65.3	60	-	○	○
1400 x 900	55.9	60	-	○	○	
1600 x 1200	75	60	-	○	-	
Apple Macintosh	640 x 480	35.0	66.7	-	○	○
	832 x 624	49.7	74.5	-	○	○
	1024 x 768	60.2	74.9	-	○	○
	1152 x 870	68.7	75.1	-	○	-

SDTV	720 x 576	31.3	50.0	○	-	-
	720 x 480	31.5	60.0	○	-	-
HDTV	1920 x 1080	33.8	30.0	○	-	-
	1920 x 1080	28.1	25.0	○	-	-
	1280 x 720	45.0	60.0	○	-	-

○: Frequency supported - : Frequency not supported

The native resolution is 1280X800. Resolution other than native mode may be displayed with uneven size of text or lines.

Projector Dimensions

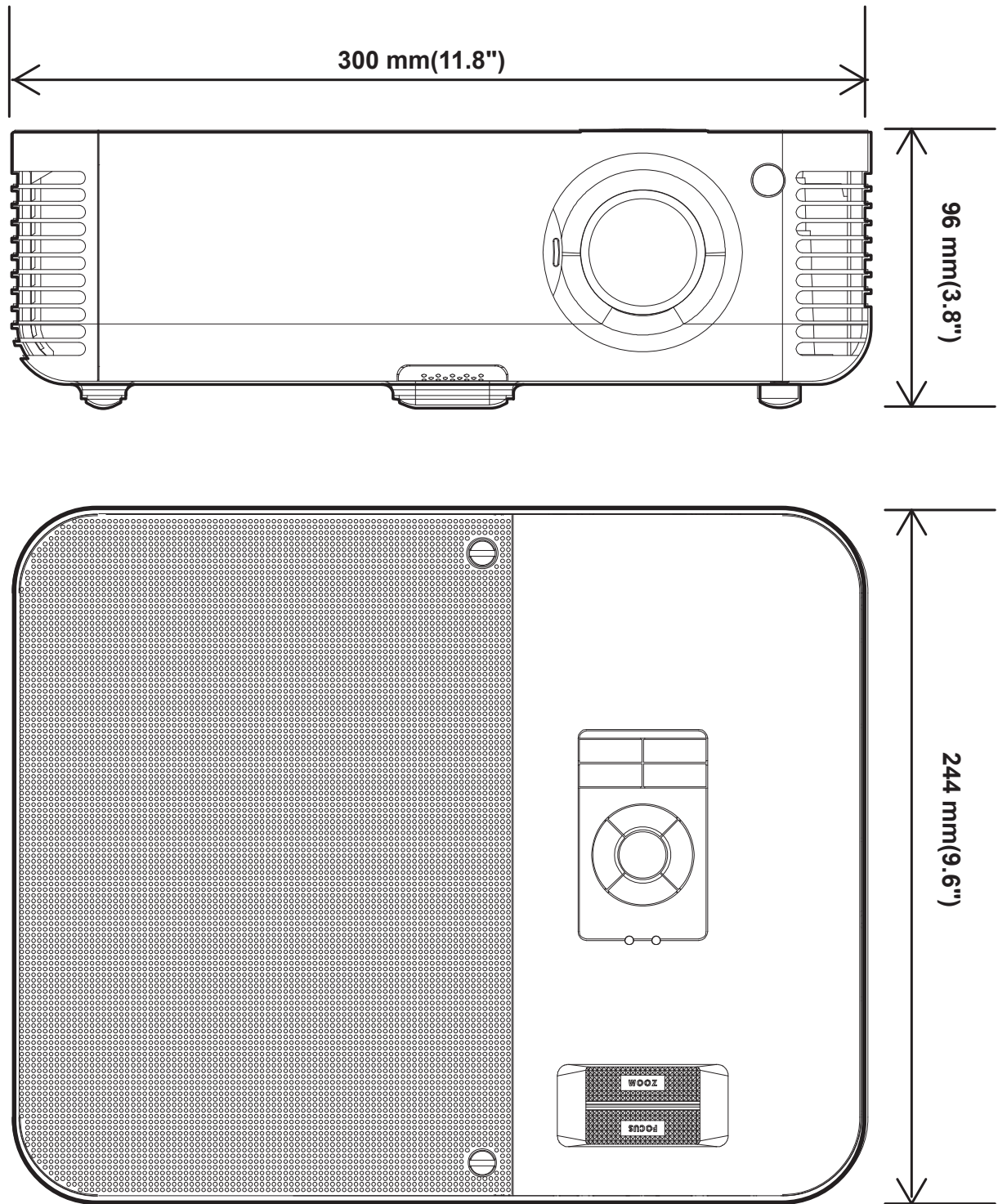



# Regulatory Compliance

## FCC Warning

This equipment has been tested and found to comply with the limits for a Class B digital device pursuant to Part 15 of the FCC Rules. These limits are designed to provide reasonable protection against harmful interference when the equipment is operated in a commercial environment.

This equipment generates, uses, and can radiate radio frequency energy and, if not installed and used in accordance with the instruction manual, may cause harmful interference to radio communications. Operation of this equipment in a residential area is likely to cause harmful interference in which case the user will be required to correct the interference at his own expense.

Changes or modifications not expressly approved by the parties responsible for compliance could void the user's authority to operate the equipment.

## Canada

This class B digital apparatus complies with Canadian ICES-003.

## Safety Certifications

FCC Class B, UL, C-UL, CE, CB, CCC, C-Tick, PSB, PCT, ICES-003 (Class B).

## EN 55022 Warning

This is a Class B product. In a domestic environment, it may cause radio interference, in which case the user may be required to take adequate measures. The typical use is in a conference room, meeting room, or auditorium.

## **Planar Systems, Inc.**

Corporate Headquarters  
1195 NW Compton Drive  
Beaverton, OR 97006-1992

## **Planar Customer Support**

Telephone:

US: 1-866-PLANAR1 (866) 752-6271

Outside US: (503) 748-5799

E-mail: [PlanarSupport@planar.com](mailto:PlanarSupport@planar.com)

Online Technical Library: <http://www.planar.com/support>

24/7 Technical Support

© 2008 Planar Systems, Inc. Planar is a registered trademark of Planar Systems, Inc.

Other brands and names are the property of their respective owners.

Technical information in this document is subject to change without notice

P/N: 020-0648-00A